

# 1986 JS550 PARTS DIAGRAM

## DRIVE SHAFT

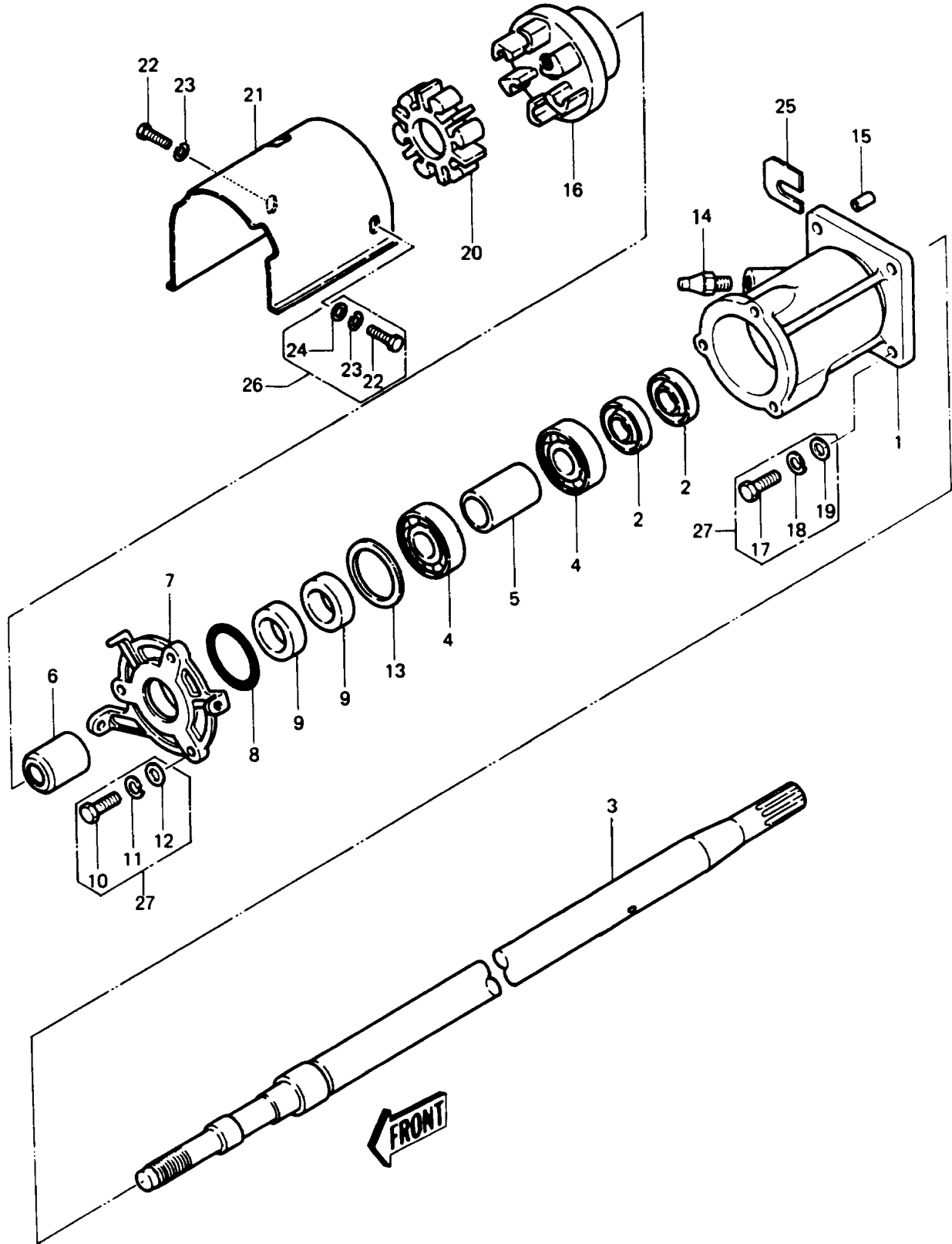

# 1986 JS550 PARTS LIST

## DRIVE SHAFT

ITEM NAME	PART NUMBER	QUANTITY
BOLT,8X25 (Ref # 10)	110R0825	3
WASHER-SPRING,8MM (Ref # 11)	461S0800	3
WASHER-PLAIN,8MM (Ref # 12)	411S0800	3
SHIM,T=0.3 (Ref # 13A)	92025-503	AR
SHIM,T=0.15 (Ref # 13)	92025-502	AR
FITTING,GREASE (Ref # 14)	92005-501	1
PIN-DOWEL (Ref # 15)	551R0612	2
COUPLING (Ref # 16)	42034-3005	1
BOLT,8X25 (Ref # 17)	110R0825	4
WASHER-SPRING,8MM (Ref # 18)	461S0800	4
WASHER-PLAIN,8MM (Ref # 19)	411S0800	3
DAMPER,COUPLING (Ref # 20)	92075-520	1
COVER,COUPLING (Ref # 21)	59036-567	1
BOLT,6X16 (Ref # 22)	110R0616	3
WASHER-SPRING,6MM (Ref # 23)	461S0600	3
WASHER-PLAIN,6MM (Ref # 24)	411S0600	2
SHIM,T=0.5MM (Ref # 25A)	92025-3702	AR
SHIM,T=1.0MM (Ref # 25B)	92025-3703	AR
SHIM,T=1.5MM (Ref # 25C)	92025-3704	AR
SHIM,T=0.3MM (Ref # 25)	92025-3701	AR
HOUSING-BEARING (Ref # 1)	41046-502	1
SEAL-OIL,AC1799EX (Ref # 2)	92050-501	2
SHAFT,DRIVE (Ref # 3)	13107-3008	1
BEARING-BALL,#6305C3 (Ref # 4)	601B6305	2
COLLAR (Ref # 5)	92027-502	1
SLEEVE,BEARING (Ref # 6)	42036-501	1
COVER,BEARING (Ref # 7)	14025-3008	1
RING-O (Ref # 8)	92055-501	1
SEAL-OIL,AC1799EX (Ref # 9)	92050-501	2