

# 1975 MT1C PARTS DIAGRAM

CRANKSHAFT/PISTON ('76-'80)

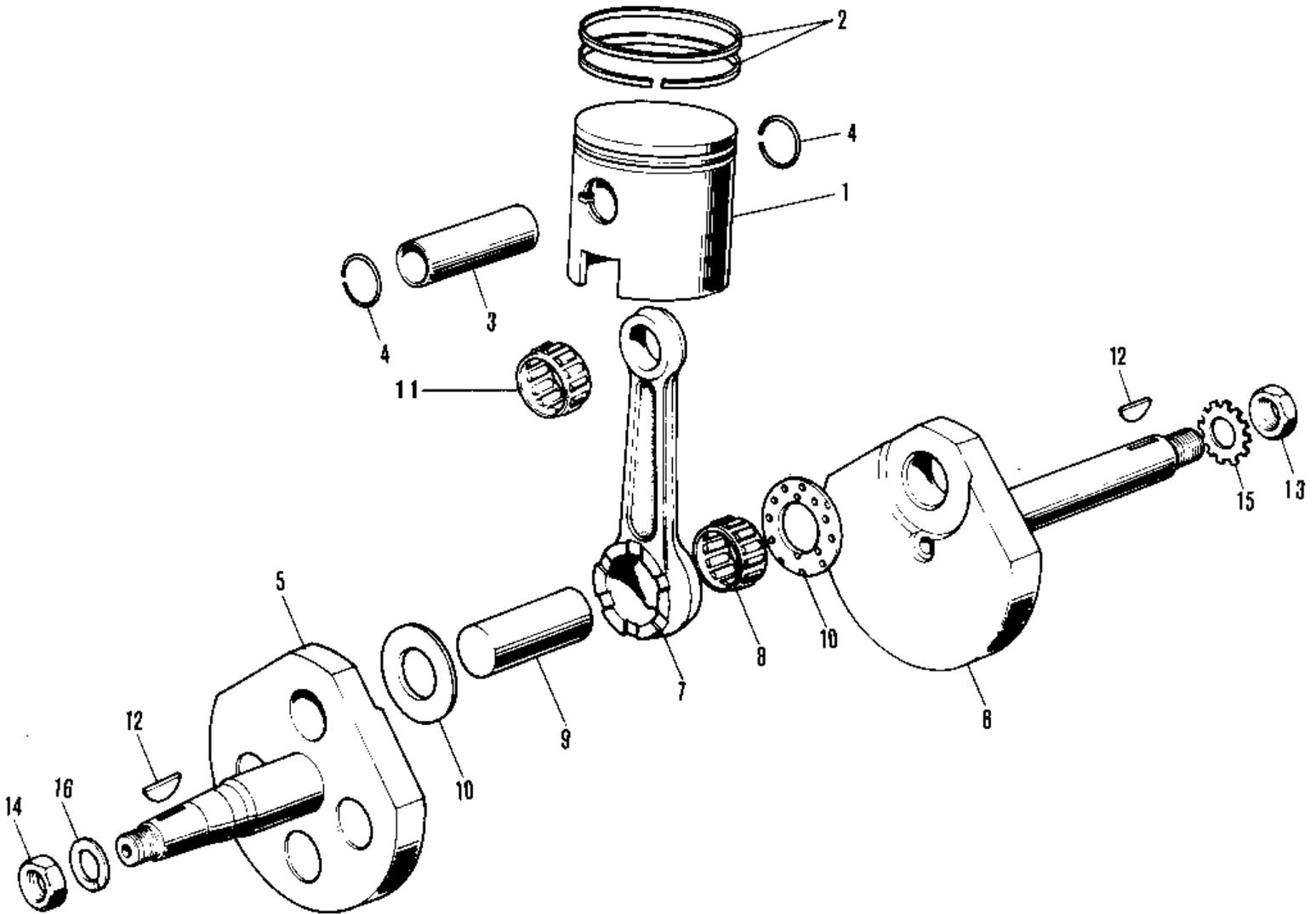

# 1975 MT1C PARTS LIST

## CRANKSHAFT/PISTON ('76-'80)

ITEM NAME	PART NUMBER	QUANTITY
PISTON,STD (Ref # 1)	13001-047	
PISTON,0.020' O.S (Ref # 1)	13029-047	
PISTON,0.040' O.S (Ref # 1)	13027-027	
RING SET,STD (Ref # 2)	13008-029	
RING SET,0.020' O.S (Ref # 2)	13025-034	
RING SET,0.040' O.S (Ref # 2)	13024-037	
PIN-PISTON (Ref # 3)	13002-019	
CIRCLIP PISTON PIN (Ref # 4)	92036-007	
CRANK - CONROD ASSY (Ref # 5 10)	13036-030	
CRANKSHAFT L.H (Ref # 5)	13037-043	
CRANKSHAFT R.H (Ref # 6)	13038-039	
CONNECTING ROD SET (Ref # 7 10)	13044-015	
NEEDLE BEARING-BG END (Ref # 8)	13034-002	
CRANK PIN (Ref # 9)	13035-024	
WASHER-SIDE (Ref # 10)	92026-002	
BRG N72KTV030 (Ref # 11)	13033-028	
WOODRUFF KEY (Ref # 12)	92038-001	
NUT,12MM (Ref # 13)	92016-024	
NUT,10MM (Ref # 14)	314B1000	
WASHER LOCK 12MM (Ref # 15)	464H1200	
WASHER SPRING 10MM (Ref # 16)	461F1000	