

# 1975 MT1C PARTS DIAGRAM

GEAR CHANGE MECHANISM ('76-'80)

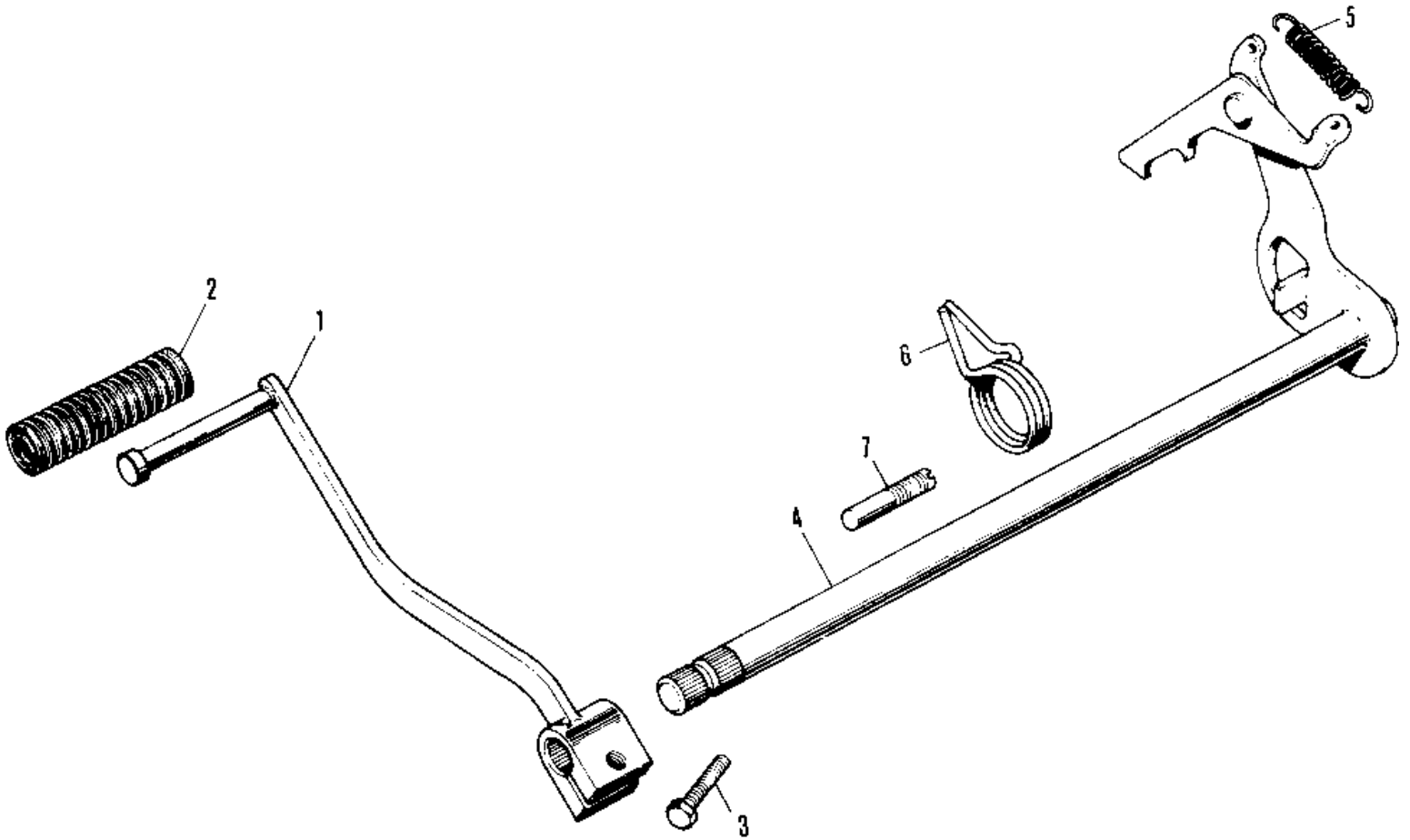

# 1975 MT1C PARTS LIST

## GEAR CHANGE MECHANISM ('76-'80)

ITEM NAME	PART NUMBER	QUANTITY
PEDAL SET GEAR CHANGE (Ref # 1)	13242-004	
RUBBER CHANGE PEDAL (Ref # 2)	13157-004	
BOLT-UPSET,6X20 (Ref # 3)	112G0620	
LEVER ASSY GEAR CHNG (Ref # 4)	13161-021	
SPRING RATCHET PA (Ref # 5)	92081-003	
SPRING (Ref # 6)	92083-001	
PIN-CHANGE PEDAL (Ref # 7)	92043-061	