

1977 KV75-A6 PARTS DIAGRAM

SWING ARM/SHOCK ABSORBERS ('76-'80)

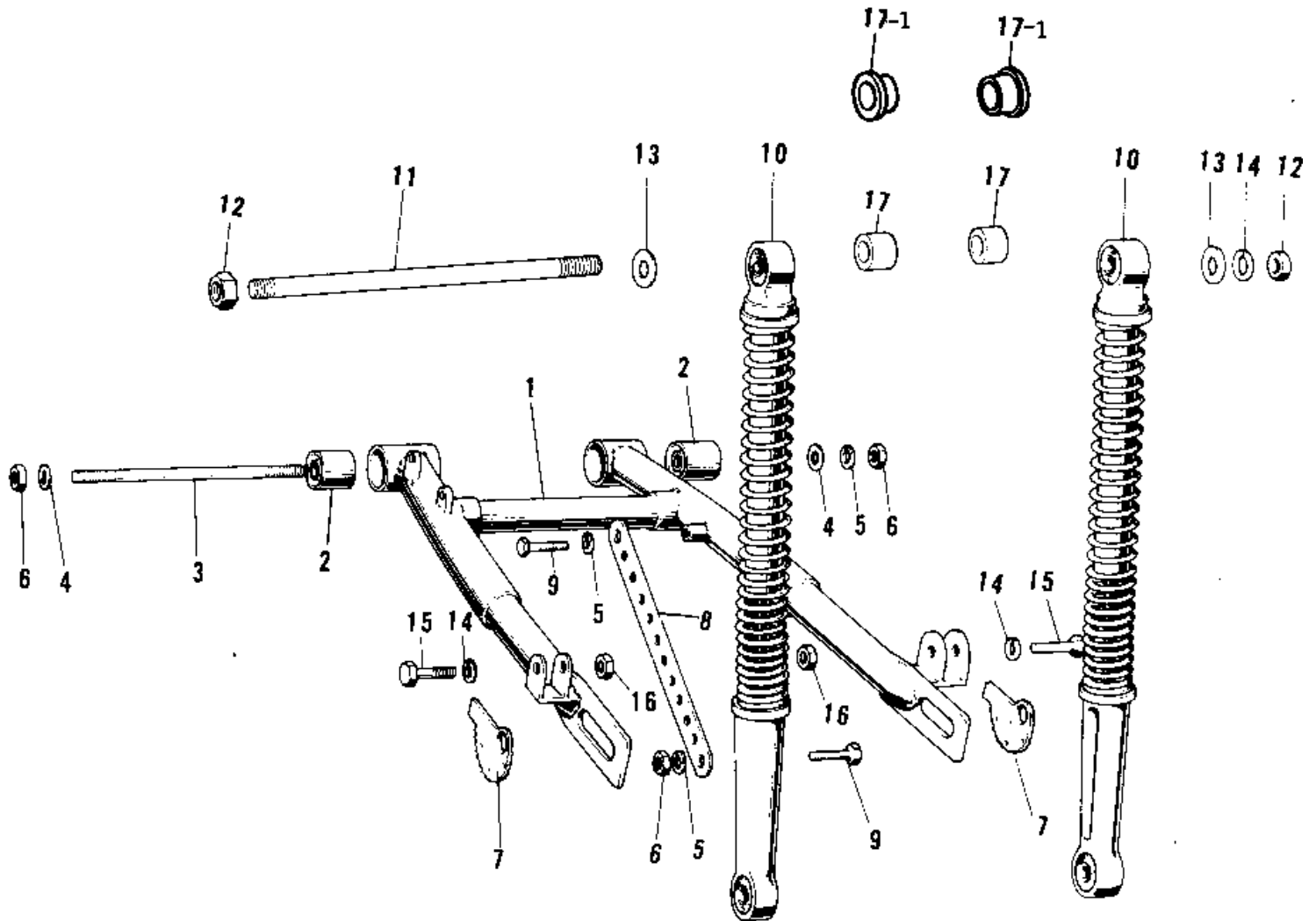

1977 KV75-A6 PARTS LIST

SWING ARM/SHOCK ABSORBERS ('76-'80)

ITEM NAME	PART NUMBER	QUANTITY
ARM-SWING (Ref # 1)	33001-037	
BUSH SWING ARM SHAFT (Ref # 2)	92092-006	
SHAFT SWING ARM PIVOT (Ref # 3)	33032-008	
WASHER PLAIN 10MM (Ref # 4)	410B1000	
WASHER SPRING 10MM (Ref # 5)	461F1000	
NUT,10MM (Ref # 6)	314B1000	
ADJUSTER-CHAIN (Ref # 7)	33040-042	
TORQUE LINK-REAR BRK (Ref # 8)	43007-025	
BOLT,HEX HEAD,10X18 (Ref # 9)	113G1018	
SHOCK ABSBR RR (Ref # 10)	45014-065	
SHOCK ABSBR RR (Ref # 10)	45014-1014	
STUD,12MM (Ref # 11)	92006-006	
NUT-HEX-FINE (Ref # 12)	314B1200	
NUT-HEX-FINE (Ref # 12)	314B1200	
WASHER PLAIN 12MM (Ref # 13)	411B1200	
WASHER SPRING 12MM (Ref # 14)	461F1200	
BOLT-HEX HEAD,12X36 (Ref # 15)	113B1236A	
NUT-HEX-FINE,12MM (Ref # 16)	315B1200	
COLLAR (Ref # 17)	92027-257	
COLLAR,REAR SHOCK (Ref # 17-1)	92027-1050	