

1979 KV75-A8 PARTS DIAGRAM

SWING ARM/SHOCK ABSORBERS ('76-'80)

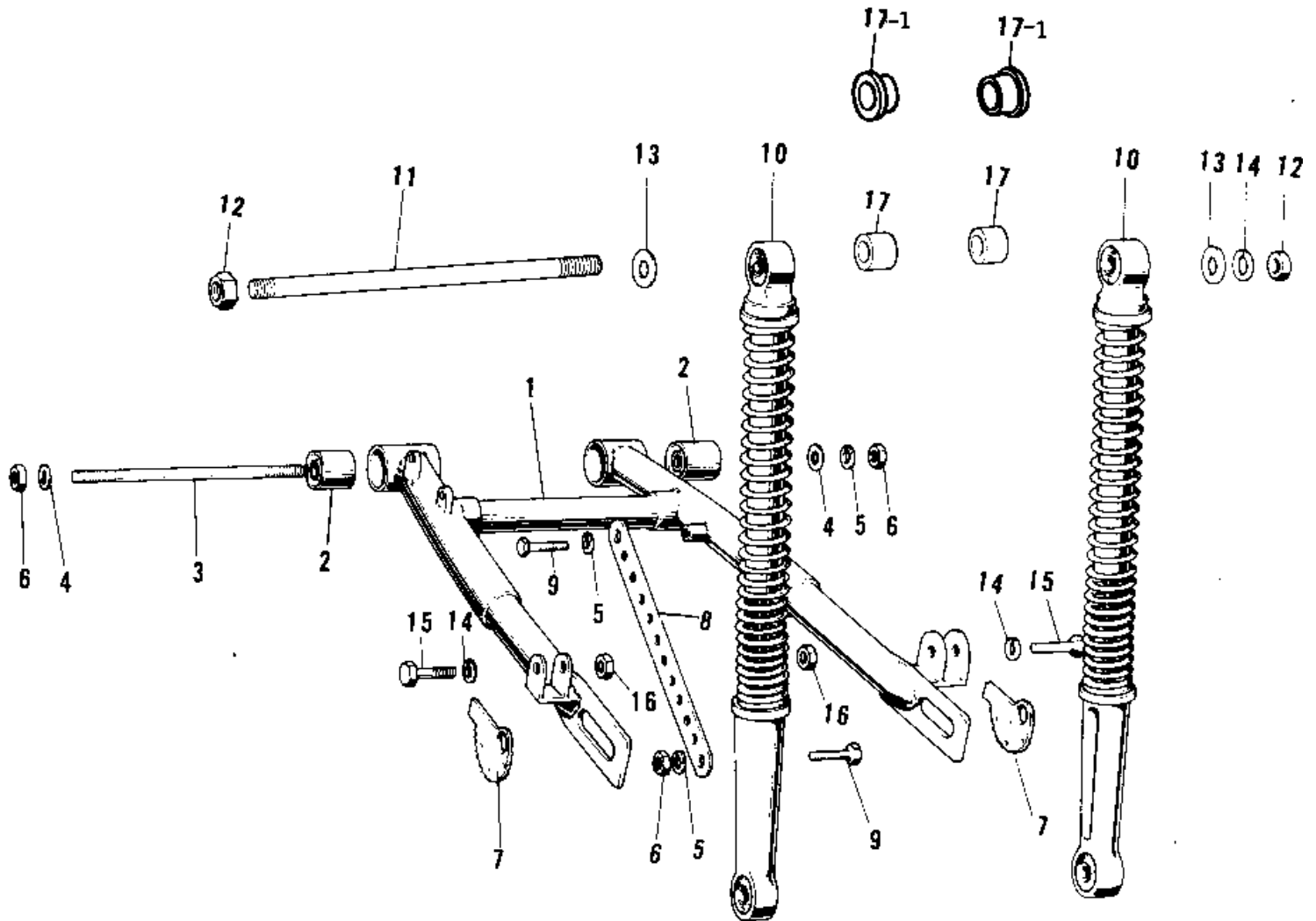

1979 KV75-A8 PARTS LIST

SWING ARM/SHOCK ABSORBERS ('76-'80)

ITEM NAME	PART NUMBER	QUANTITY
ARM-SWING (Ref # 1)	33001-037	1
BUSH SWING ARM SHAFT (Ref # 2)	92092-006	2
SHAFT SWING ARM PIVOT (Ref # 3)	33032-008	1
WASHER PLAIN 10MM (Ref # 4)	410B1000	2
WASHER SPRING 10MM (Ref # 5)	461F1000	3
NUT,10MM (Ref # 6)	314B1000	3
ADJUSTER-CHAIN (Ref # 7)	33040-042	2
TORQUE LINK-REAR BRK (Ref # 8)	43007-025	1
BOLT,HEX HEAD,10X18 (Ref # 9)	113G1018	2
SHOCK ABSBR RR (Ref # 10)	45014-065	2
SHOCK ABSBR RR (Ref # 10)	45014-1014	2
STUD,12MM (Ref # 11)	92006-006	1
NUT-HEX-FINE (Ref # 12)	314B1200	2
NUT-HEX-FINE (Ref # 12)	314B1200	2
WASHER PLAIN 12MM (Ref # 13)	411B1200	2
WASHER SPRING 12MM (Ref # 14)	461F1200	3
BOLT-HEX HEAD,12X36 (Ref # 15)	113B1236A	2
NUT-HEX-FINE,12MM (Ref # 16)	315B1200	2
COLLAR (Ref # 17)	92027-257	2
COLLAR,REAR SHOCK (Ref # 17-1)	92027-1050	2