

1979 KX80 PARTS DIAGRAM

TRANSMISSION

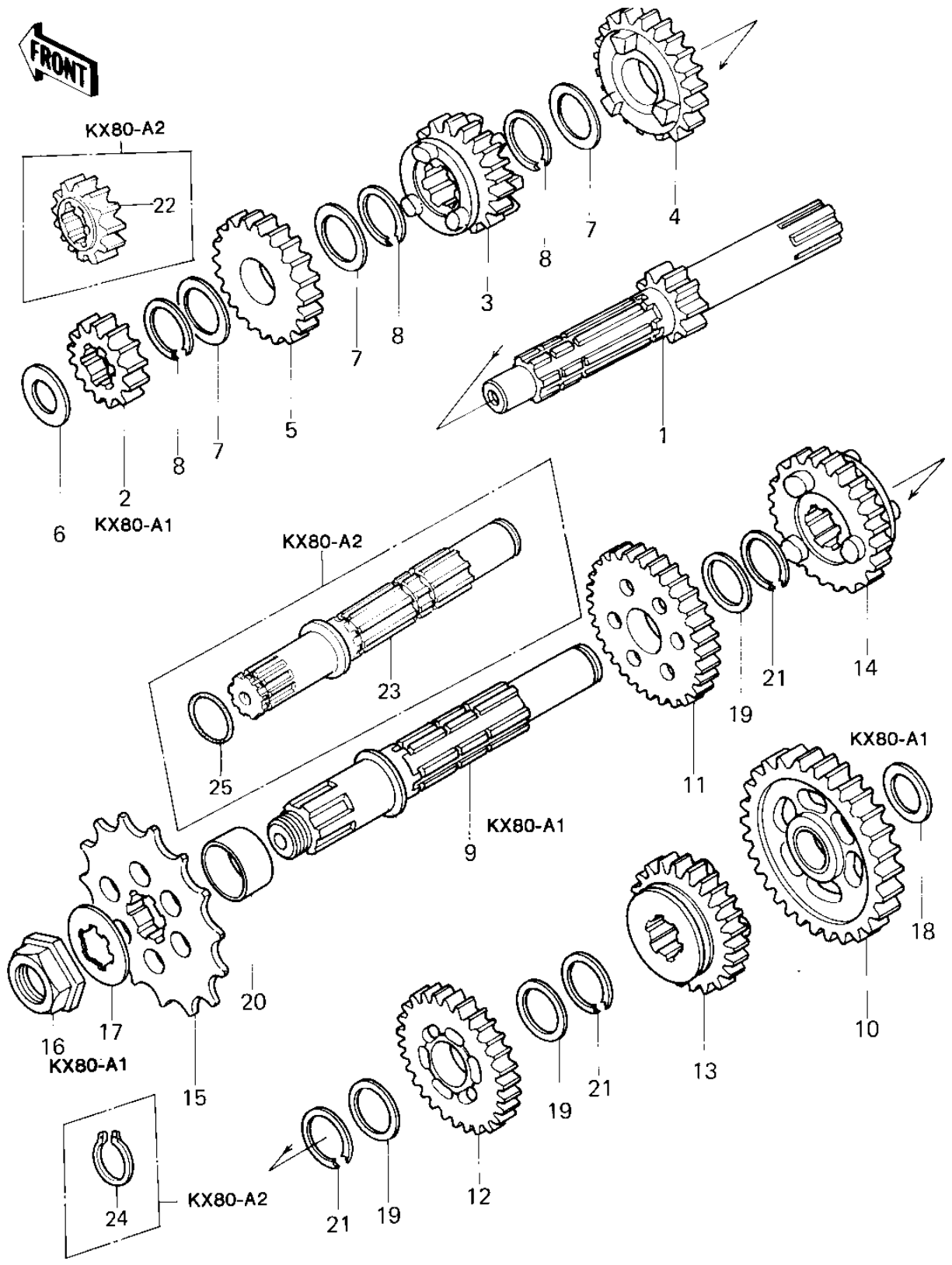

1979 KX80 PARTS LIST

TRANSMISSION

ITEM NAME	PART NUMBER	QUANTITY
SHAFT,DRIVE (Ref # 1)	13127-1011	1
SHAFT,DRIVE,14T (Ref # 1)	13127-1020	1
2ND GEAR,DRIVE SHAFT (Ref # 2)	13129-1106	1
3RD GEAR,DRIVE SHAFT (Ref # 3)	13129-1108	1
3RD GEAR,DRIVE SHAFT (Ref # 3)	13129-1151	1
4TH GEAR,DRIVE SHAFT (Ref # 4)	13129-1110	1
TOP GEAR,DRIVE SHAFT (Ref # 5)	13129-1112	1
WASHER PLAIN 12MM (Ref # 6)	92022-123	1
SPACER,17.2X23X0.5 (Ref # 7)	92026-1037	3
RING,SNAP (Ref # 8)	92033-1060	3
SHAFT,OUTPUT (Ref # 9)	13128-1018	1
LOW GEAR,OUTPUT SHAFT (Ref # 10)	13129-1105	1
LOW GEAR,OUTPUT SHAFT (Ref # 10)	13129-1152	1
2ND GEAR,OUTPUT SHAFT (Ref # 11)	13129-1107	1
2ND GEAR,OUTPUT SHAFT (Ref # 11)	13129-1153	1
3RD GEAR,OUTPUT SHAFT (Ref # 12)	13129-1109	1
4TH GEAR,OUTPUT SHAFT (Ref # 13)	13129-1111	1
TOP GEAR,OUTPUT SHAFT (Ref # 14)	13129-1113	1
SPROCKET,ENGINE,14T (Ref # 15)	13144-1022	1
SPROCKET,ENGINE,13T (Ref # 15)	13144-1023	(1
SPROCKET,ENGINE,15T (Ref # 15)	13144-1024	(1
NUT,14M/M (Ref # 16)	92015-1062	1
WASHER,SPLINE (Ref # 17)	92022-1113	1
SPACER,15.3X22X1.0 (Ref # 18)	92026-1036	1
SPACER,18.2X24X0.5 (Ref # 19)	92026-1039	3
COLLAR,ENG SPROCKET (Ref # 20)	92027-1077	1
CIRCLIP (Ref # 21)	92033-028	3
2ND GEAR,DRIVE SHAFT (Ref # 22)	13129-1150	1
SHAFT,OUTPUT (Ref # 23)	13128-1024	1

1979 KX80 PARTS LIST

TRANSMISSION

ITEM NAME	PART NUMBER	QUANTITY
CIRCLIP, 20MM (Ref # 24)	480J2000	1
"O" RING (Ref # 25)	92055-022	1