

# 1980 KDX80 PARTS DIAGRAM

CRANKSHAFT/PISTON

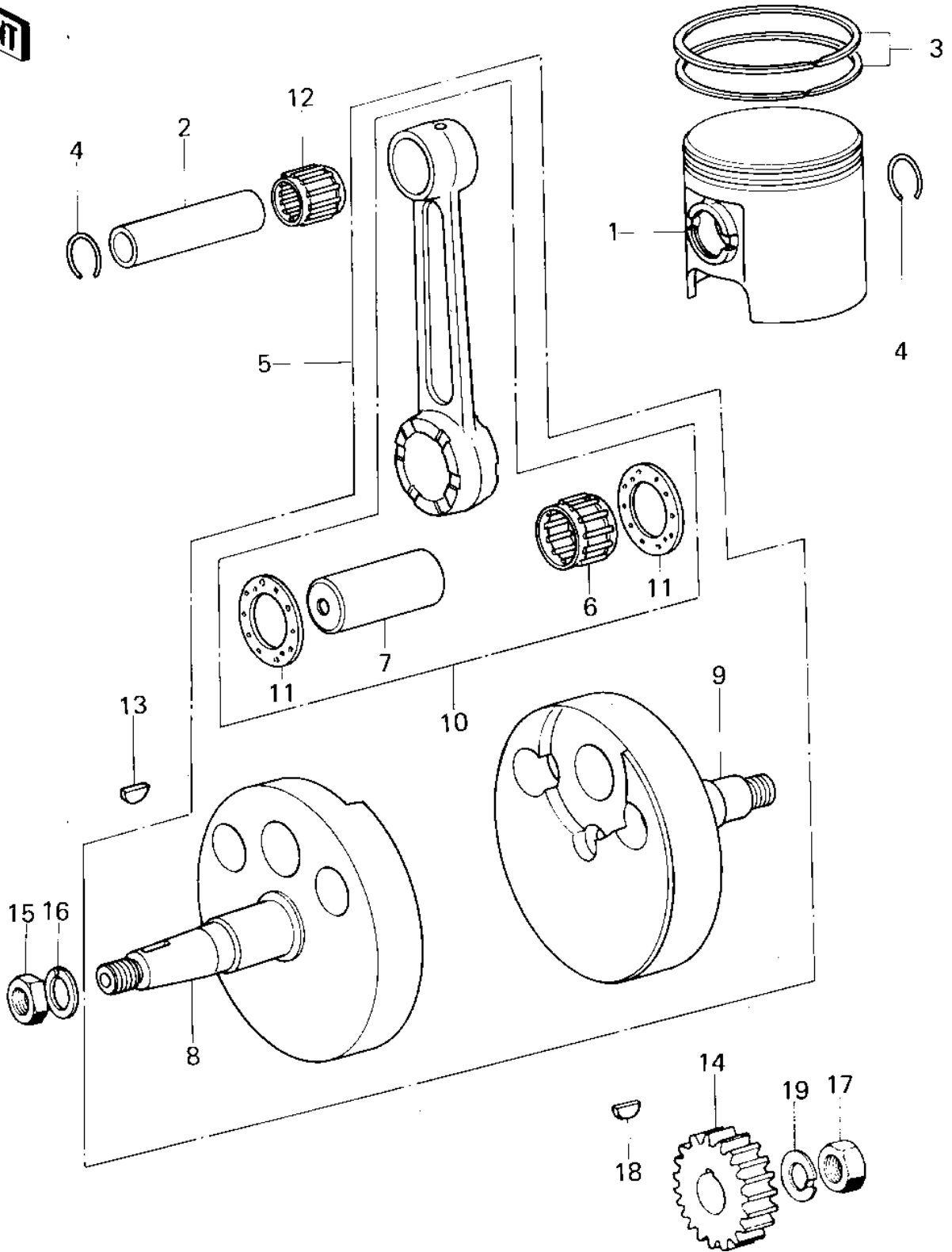

# 1980 KDX80 PARTS LIST

## CRANKSHAFT/PISTON

ITEM NAME	PART NUMBER	QUANTITY
PISTON-ENGINE (Ref # 1)	13001-1082	1
PIN-PISTON (Ref # 2)	13002-1009	1
RING SET,PISTON,STD (Ref # 3)	13008-5011	1
CIRCLIP PISTON PIN (Ref # 4)	92036-003	2
CRANKSHAFT ASSY (Ref # 5)	13031-1027	1
BEARING,NEEDLE (Ref # 6)	13034-1015	1
PIN,CRANK (Ref # 7)	13035-1002	1
CRANKSHAFT,L.H. (Ref # 8)	13037-1053	1
CRANKSHAFT,R.H. (Ref # 9)	13037-1054	1
CONNECTING ROD SET (Ref # 10)	13044-5014	1
WASHER SIDE (Ref # 11)	92025-005	2
BEARING,SMALL END (Ref # 12)	13033-030	1
WOODRUFF KEY (Ref # 13)	510A3200	1
GEAR,PRIMARY (Ref # 14)	13097-1021	1
NUT,10M/M (Ref # 15)	314G1000	1
WASHER SPRING 10MM (Ref # 16)	461F1000	1
NUT 12MM (Ref # 17)	92015-006	1
WOODRUFF KEY PRY PINI (Ref # 18)	92038-003	1
WASHER LOCK 12MM (Ref # 19)	92024-003	1