

1992 550 SX PARTS DIAGRAM

Cylinder Head/Cylinder

E1110

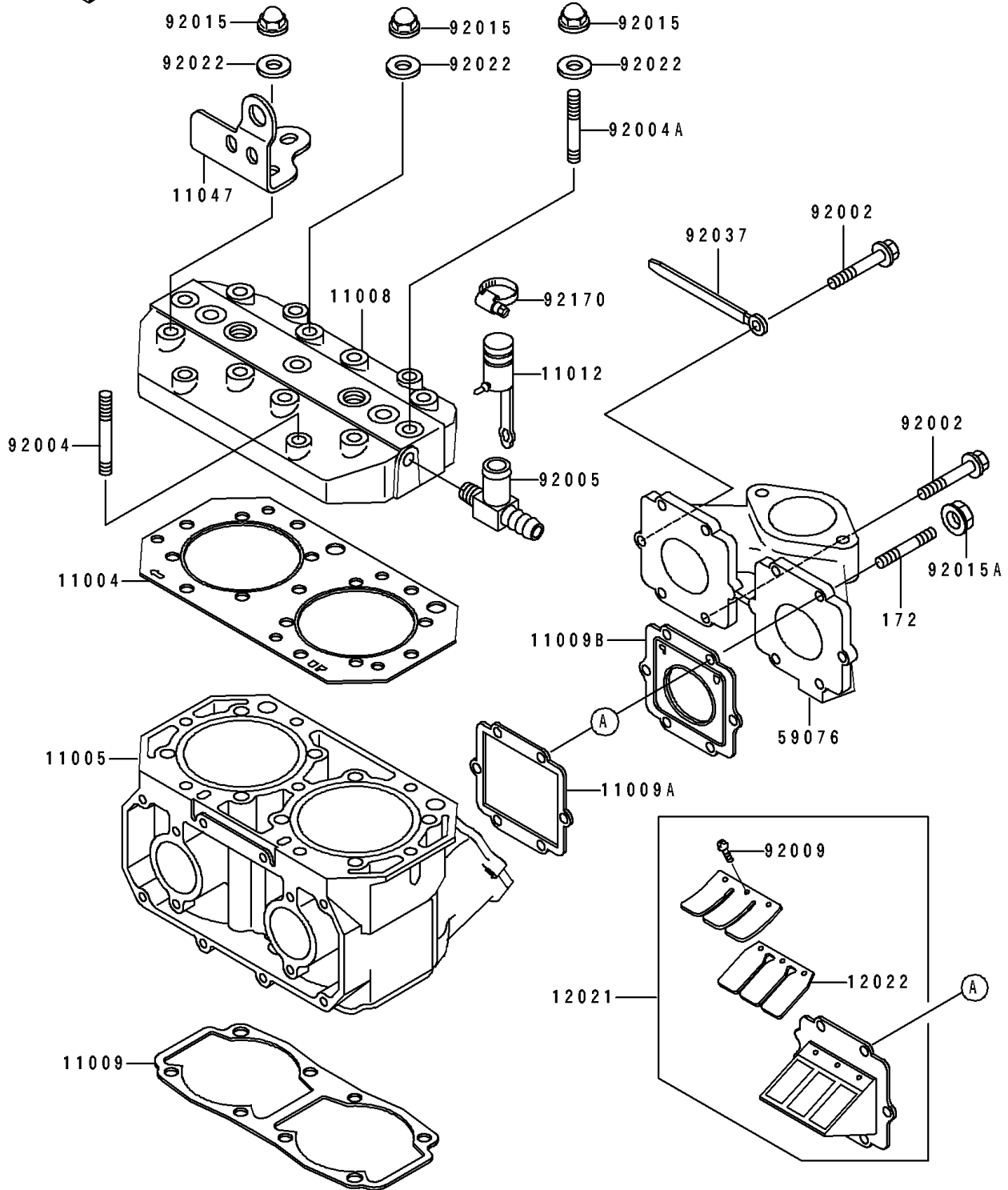

1992 550 SX PARTS LIST

Cylinder Head/Cylinder

ITEM NAME	PART NUMBER	QUANTITY
GASKET-HEAD (Ref # 11004)	11004-3706	1
CYLINDER-ENGINE (Ref # 11005)	11005-3711	1
HEAD-COMP-CYLINDER (Ref # 11008)	11008-3701	1
GASKET,CYLINDER BASE (Ref # 11009)	11009-3780	1
GASKET,REED VALVE (Ref # 11009A)	11009-3787	2
GASKET,INTAKE MANIFOLD (Ref # 11009B)	11009-3788	2
CAP (Ref # 11012)	11012-3757	1
BRACKET (Ref # 11047)	11047-3744	1
VALVE-ASSY-REED (Ref # 12021)	12021-3705	2
VALVE-REED (Ref # 12022)	12022-1063	4
MANIFOLD-INTAKE (Ref # 59076)	59076-3709	1
BOLT,6X25 (Ref # 92002)	92002-3714	6
STUD,8X42 (Ref # 92004)	92004-3726	4
STUD,8X50 (Ref # 92004A)	92004-3727	3
FITTING (Ref # 92005)	92005-3711	1
SCREW,REED VALVE (Ref # 92009)	92009-1014	12
NUT,CAP,8MM (Ref # 92015)	92015-1371	15
NUT,6MM (Ref # 92015A)	92015-3767	4
WASHER,8.2X18X1.5 (Ref # 92022)	92022-1964	15
CLAMP,L=100 (Ref # 92037)	92037-3736	1
CLAMP (Ref # 92170)	92170-3729	1
BOLT-STUD (Ref # 172)	172R0620	4