

1969 Bushmaster PARTS DIAGRAM

KICKSTARTER MECHANISM ('69-'73)

Ref.No. Part N

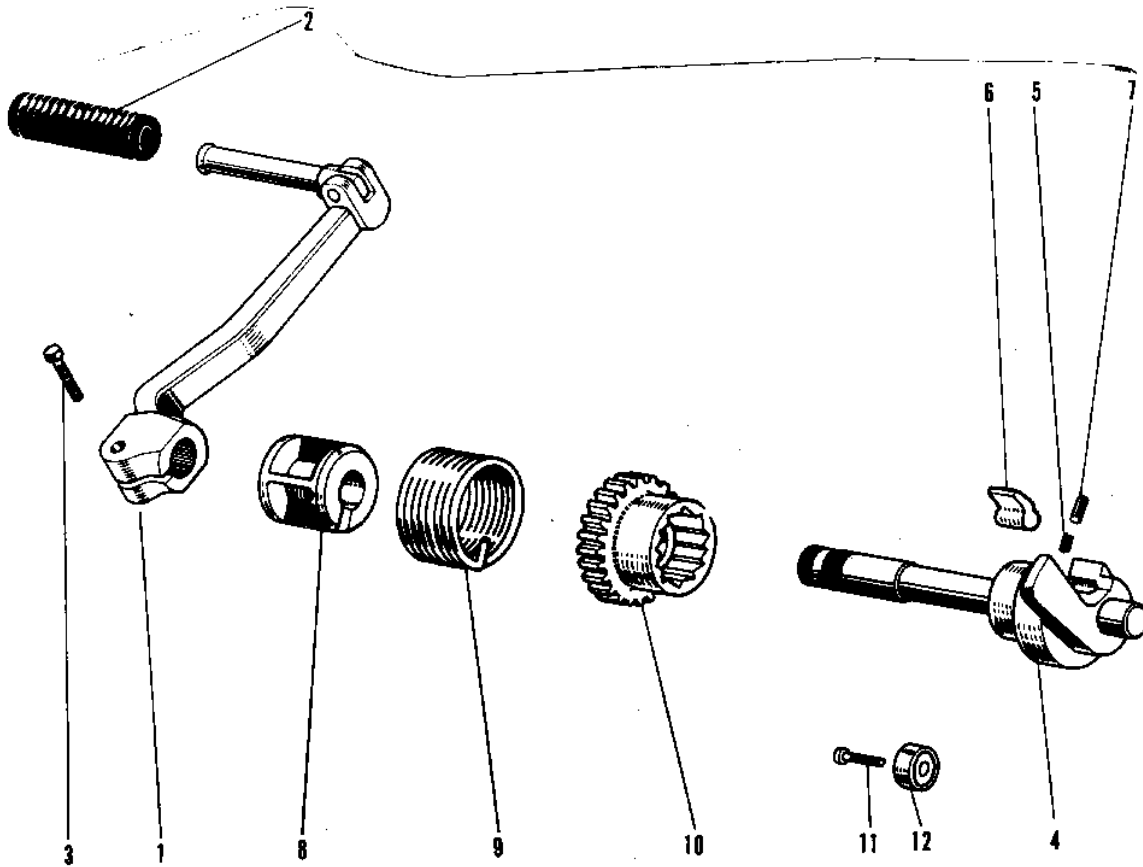

1	13058-
	13058-
2	13063-
3	114B08
4	13066-
5	92081-
6	13069-
7	92043-
8	13070-
9	92083-
10	13068-
11	221B06
12	13072-

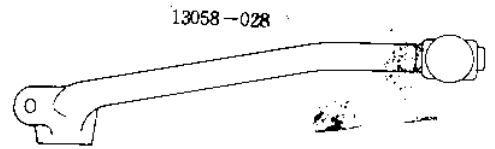
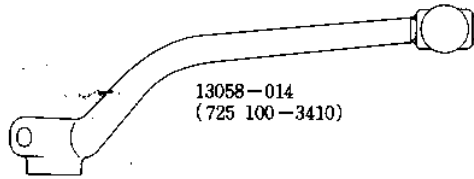
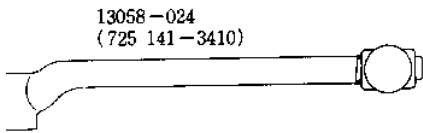

1969 Bushmaster PARTS LIST

KICKSTARTER MECHANISM ('69-'73)

ITEM NAME	PART NUMBER	QUANTITY
PEDAL,KICKSTARTER (Ref # 1)	13064-012	1
RUBBER KICK PEDAL (Ref # 2)	13063-004	1
BOLT-SMALL-UPSET 8X25 (Ref # 3)	115G0825	1
SHAFT-KICK (Ref # 4)	13066-1022	1
SPRING KICK PAWL (Ref # 5)	92081-014	1
PAWL KICKSTARTER (Ref # 6)	13069-005	1
P/N,KICKSTARTER PAWL (Ref # 7)	92043-013	1
GUIDE KICK SPRING (Ref # 8)	13070-003	1
SPRING KICKSTARTER (Ref # 9)	92083-004	1
GEAR KICKSTARTER (Ref # 10)	13068-007	1
SCREW CNTSNK HD 6X20 (Ref # 11)	221B0620	1
STOPPER KICKSTARTER (Ref # 12)	13072-003	1