

1994 550 SX PARTS DIAGRAM

Crankshaft/Piston(s)

E1320

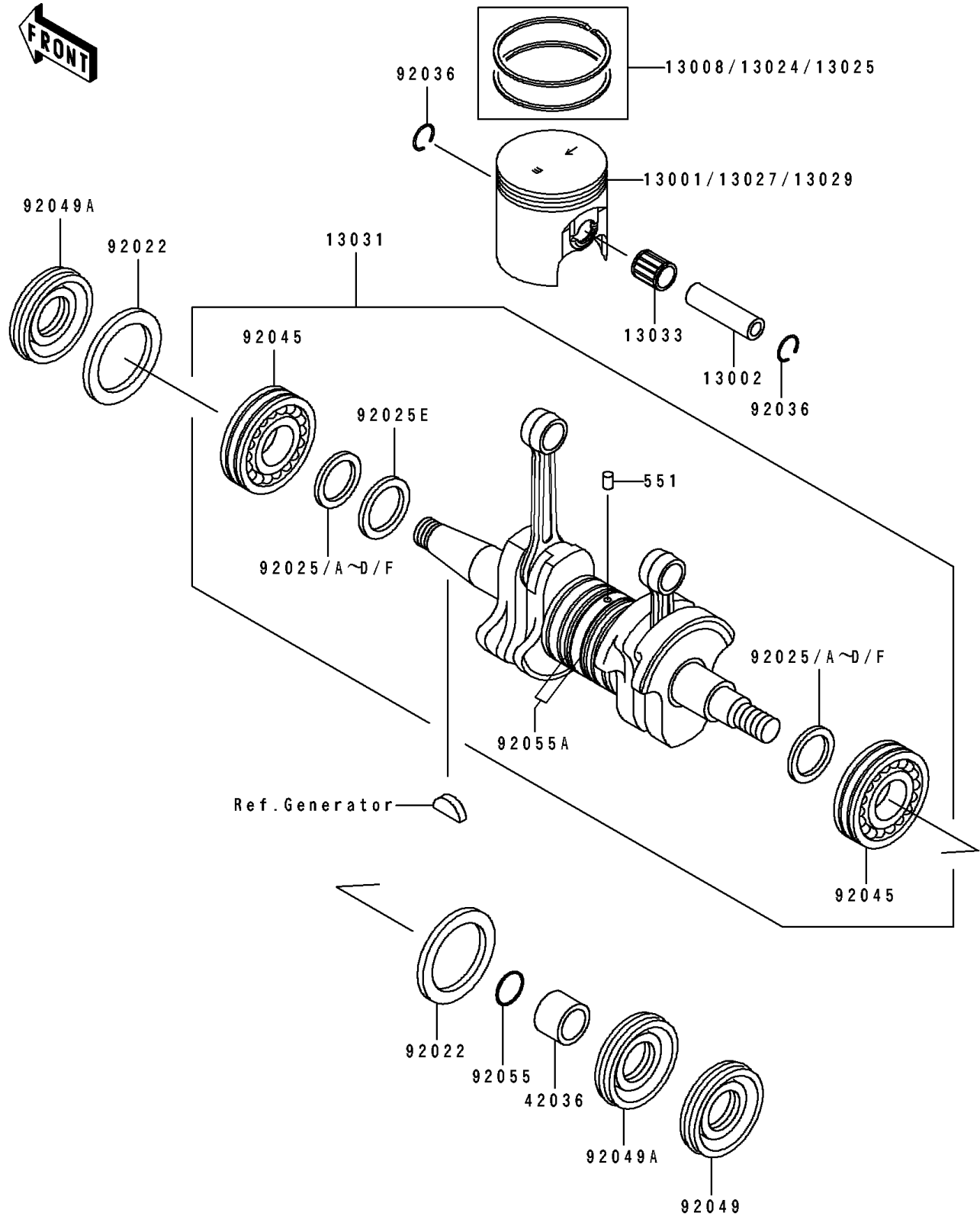

1994 550 SX PARTS LIST

Crankshaft/Piston(s)

ITEM NAME	PART NUMBER	QUANTITY
PISTON-ENGINE,STD (Ref # 13001)	13001-3704	2
PIN-PISTON (Ref # 13002)	13002-504	2
RING-SET-PISTON,STD (Ref # 13008)	13008-3703	2
RING-SET-PISTON LL,O/S 1.00 (Ref # 13024)	13024-3703	2
RING-SET-PISTON L,O/S 0.50 (Ref # 13025)	13025-3703	2
PISTON-ENGINE LL,O/S 1.00 (Ref # 13027)	13027-3704	2
PISTON-ENGINE L,O/S 0.50 (Ref # 13029)	13029-3704	2
CRANKSHAFT-COMP (Ref # 13031)	13031-3715	1
BEARING-NEEDLE,KBK16X20X22.8X6 (Ref # 13033)	13033-3005	2
SLEEVE,CRANKSHAFT OUT (Ref # 42036)	42036-3007	1
WASHER,CRANK,RH (Ref # 92022)	92022-3021	2
SHIM,T=0.1 (Ref # 92025)	92025-513	AR
SHIM,T=0.2 (Ref # 92025A)	92025-518	AR
SHIM,T=0.3 (Ref # 92025B)	92025-523	AR
SHIM,T=0.4 (Ref # 92025C)	92025-527	AR
SHIM,T=0.5 (Ref # 92025D)	92025-530	AR
SHIM,T=1.0MM (Ref # 92025E)	92025-532	1
SHIM,T=0.6 (Ref # 92025F)	92025-533	AR
RING-SNAP (Ref # 92036)	92036-507	4
BEARING-BALL (Ref # 92045)	92045-3010	2
SEAL-OIL,OIL,TCY306210 (Ref # 92049)	92049-3005	1
SEAL-OIL,OIL,DCY30629 (Ref # 92049A)	92049-3006	2
RING-O,22MM (Ref # 92055)	92055-3009	1
RING-O (Ref # 92055A)	92055-504	2
PIN-DOWEL (Ref # 551)	551A0410	1