

1969 Bushmaster PARTS DIAGRAM

FRAME/FRAME FITTINGS ('69-'73)

Re
7

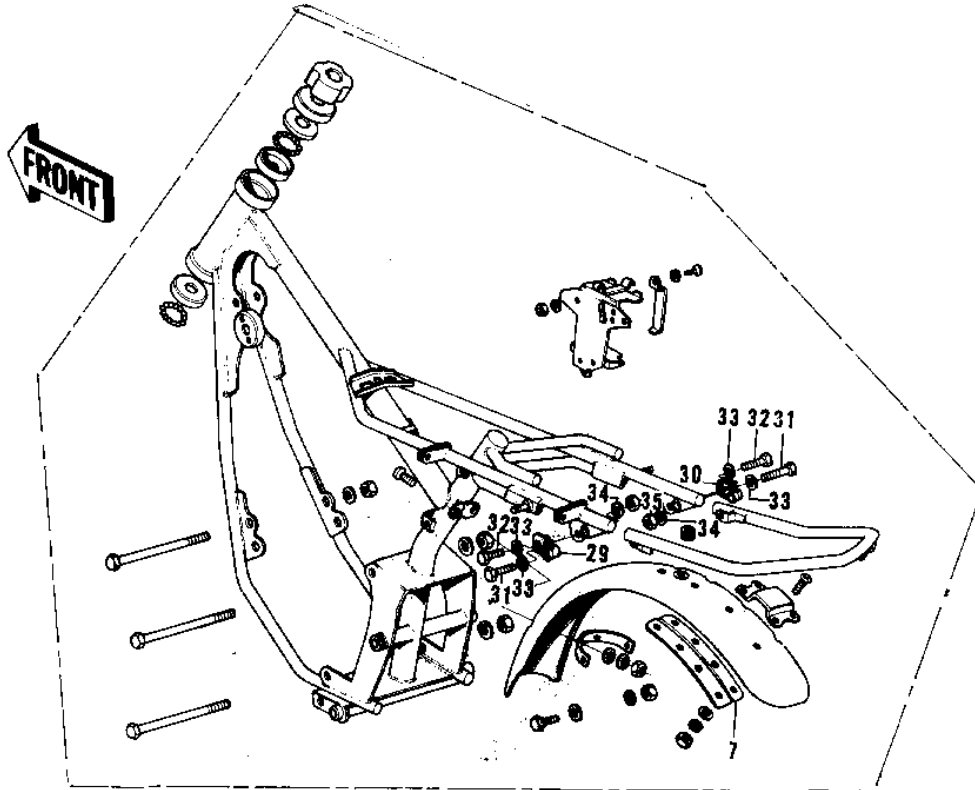
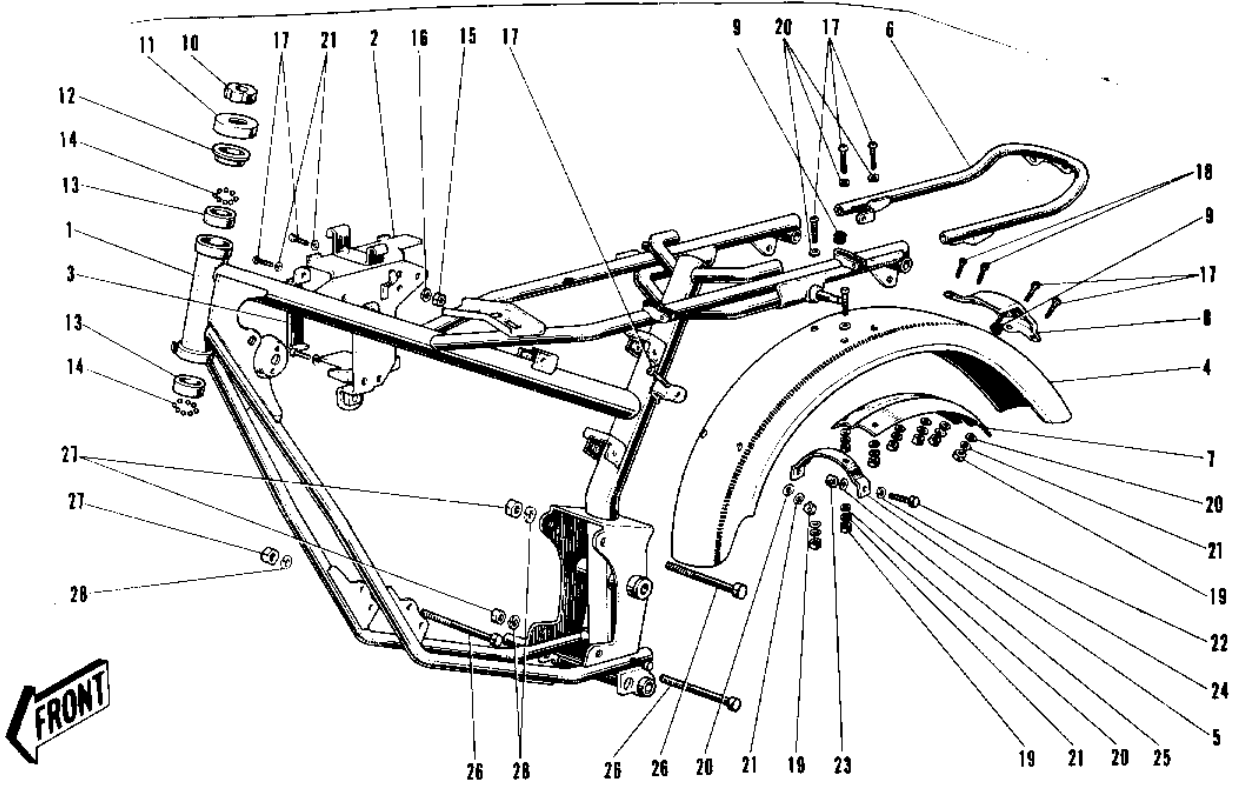

1969 Bushmaster PARTS LIST

FRAME/FRAME FITTINGS ('69-'73)

ITEM NAME	PART NUMBER	QUANTITY
FRAME (Ref # 1)	32002-017	1
BRACKET BATTERY (Ref # 2)	32093-004	1
BAND BATTERY (Ref # 3)	32100-002	1
FENDER-RR (Ref # 4)	35022-037	1
BRACKET REAR FENDER (Ref # 5)	35025-002	1
STAY REAR FENDER (Ref # 6)	35032-015	1
GUSSET-REAR FENDER (Ref # 7)	35034-016	1
BRACKET TAIL LAMP (Ref # 8)	35031-001	1
GROMMET HARNESS 10MM (Ref # 9)	92071-019	2
NUT STEERING STEM LCK (Ref # 10)	92090-006	1
CAP STEERING STEM (Ref # 11)	46098-004	1
CONE UPPER BEARING (Ref # 12)	92047-005	1
RACE BEARING (Ref # 13)	92048-004	2
BALL STEEL 3/16' (Ref # 14)	600A0600	46
NUT,5MM (Ref # 15)	311B0500	1
NUT,5MM (Ref # 15)	311B0500	1
WASHER SPRING 5MM (Ref # 16)	461F0500	1
SCREW PAN HEAD 6X12 (Ref # 17)	220B0612	8
SCREW PAN HEAD 6X14 (Ref # 18)	220B0614	2
NUT 6MM (Ref # 19)	311B0600	11
WASHER PLAIN 6MM (Ref # 20)	410B0600	14
WASHER SPRING 6MM (Ref # 21)	461F0600	10
BOLT HEX HEAD 8X40 (Ref # 22)	116B0840	2
NUT,8MM (Ref # 23)	311B0800	2
WASHER PLAIN 8MM (Ref # 24)	410B0800	2
WASHER SPRING 8MM (Ref # 25)	461F0800	2
BOLT,FLANGED,10X115 (Ref # 26)	92001-1603	4
NUT,10MM (Ref # 27)	314B1000	4
WASHER SPRING 10MM (Ref # 28)	461F1000	4