

# 1969 Bushmaster PARTS DIAGRAM

OIL PUMP (74-75)

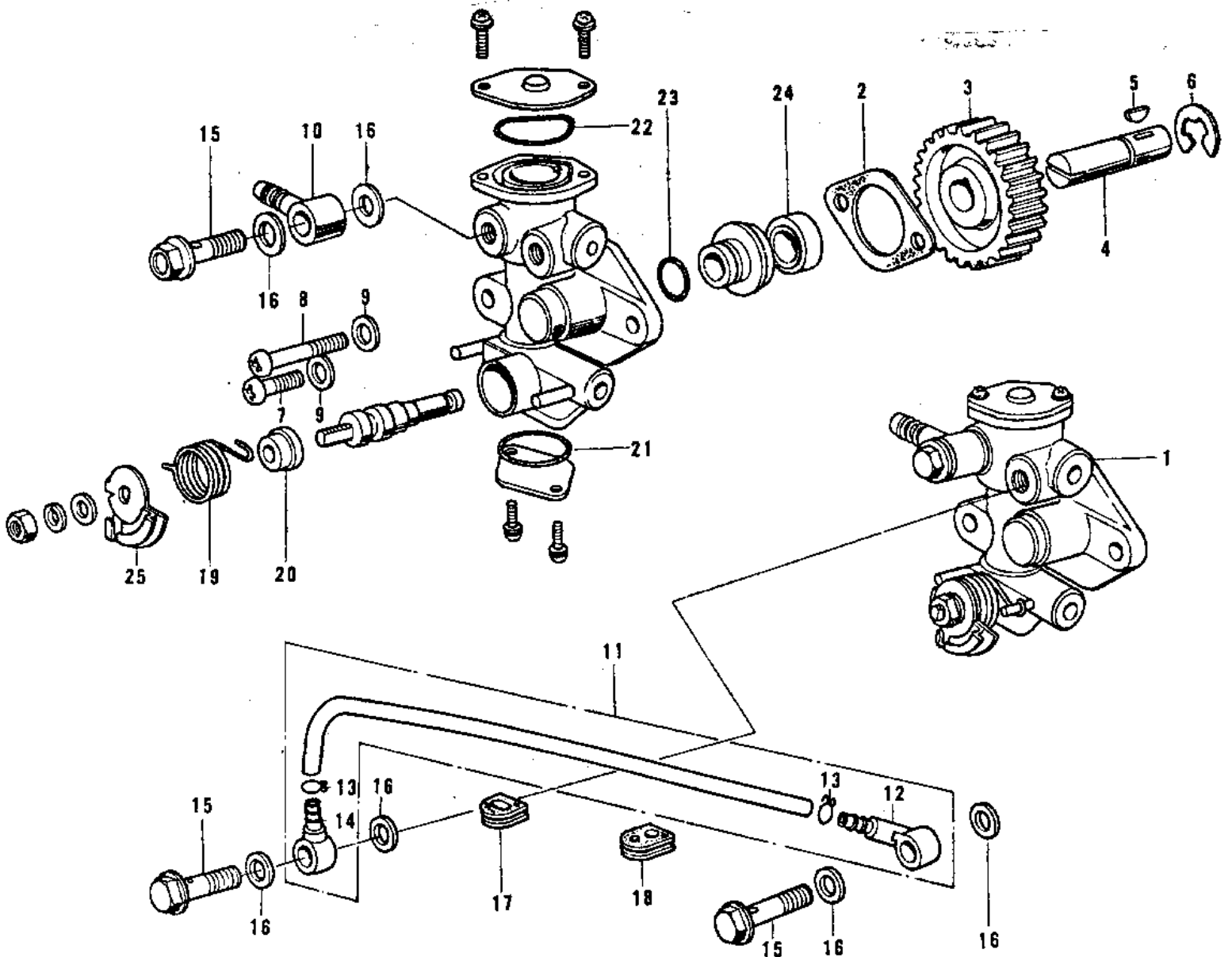

# 1969 Bushmaster PARTS LIST

## OIL PUMP (74-75)

ITEM NAME	PART NUMBER	QUANTITY
PUMP ASSY, OIL (Ref # 1)	16082-067	1
GASKET,OIL PUMP (Ref # 2)	11060-1160	1
GEAR OIL PUMP (Ref # 3)	16085-004	1
SHAFT OIL PUMP (Ref # 4)	16086-001	1
WOODRUFF KEY (Ref # 5)	510A3100	1
CIRCLIP 9MM (Ref # 6)	482K9000	1
SCREW-PAN-CROS (Ref # 7)	220B0514	1
SCREW PAN CROSS,5X28 (Ref # 8)	220B0528	1
WASHER OIL PUMP (Ref # 9)	92022-037	2
CONNECTOR BANJO (Ref # 10)	92061-009	1
PIPE,OIL (Ref # 11)	16134-021	1
VALVE,CHECK (Ref # 12)	16128-009	1
CLAMP,OIL PIPE (Ref # 13)	92036-022	2
CONNECTOR,OIL PIPE (Ref # 14)	92061-018	1
BOLT-BANJO,6MM (Ref # 15)	92060-013	3
WASHER OIL PUMP BANJO (Ref # 16)	92022-077	6
GROMMET WIRING HARN (Ref # 17)	21017-002	1
GROMMET,OIL PIPE (Ref # 18)	92071-067	1
SPRING,OIL PUMP LEVER (Ref # 19)	16093-006	1
SEAL-OIL,CAMSHAFT,"X" (Ref # 20)	92049-1294	1
"O" RING,LOWER CAP (Ref # 21)	16090-003	1
"O" RING,UPPER CAP (Ref # 22)	16088-002	1
"O" RING,OIL PUMP SHT (Ref # 23)	16090-002	1
OIL SEAL OIL PUMP SHT (Ref # 24)	16091-001	1
LEVER,OIL PUMP CABLE (Ref # 25)	16096-012	1