

1995 550 SX PARTS DIAGRAM

Jet Pump

E3191

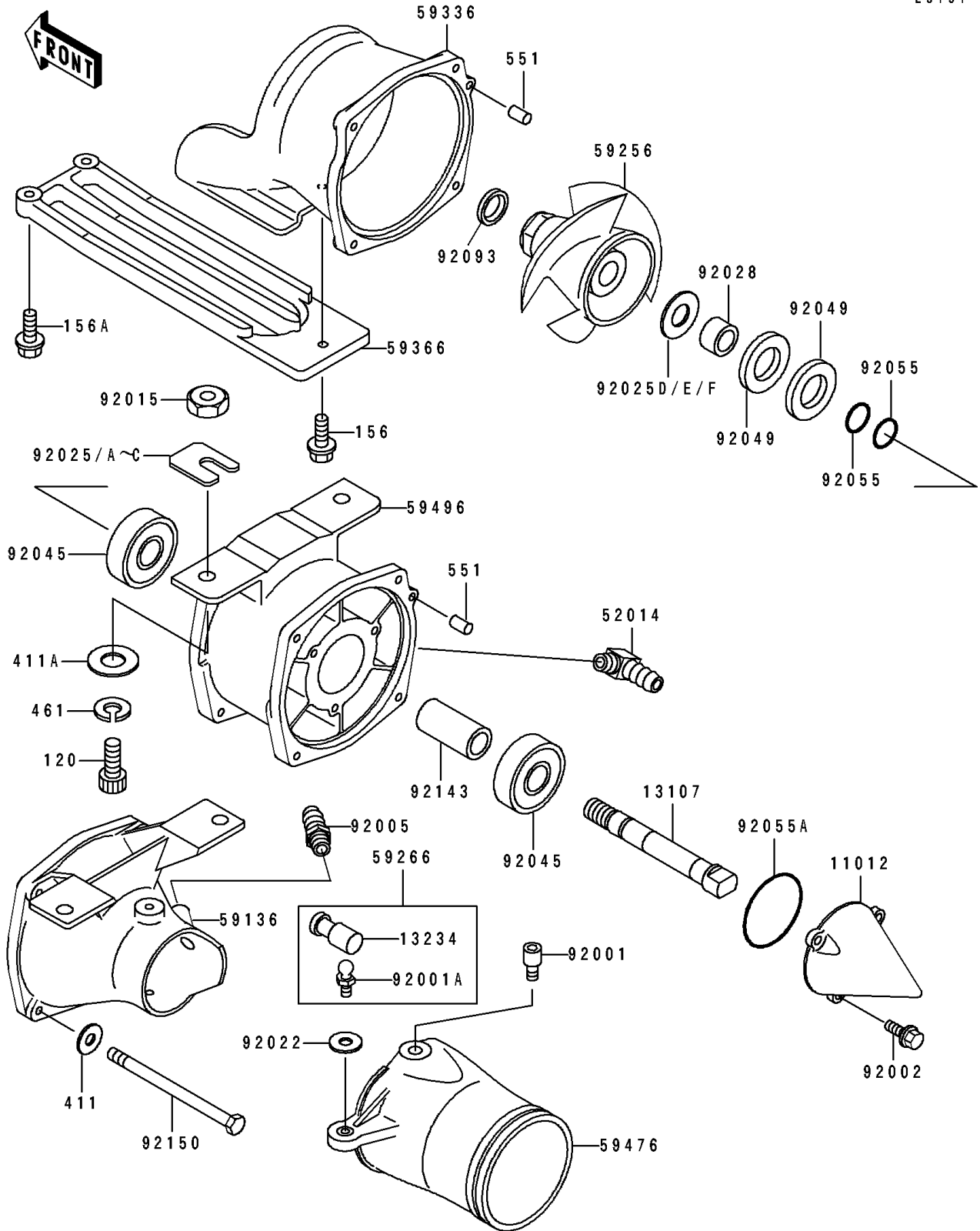

1995 550 SX PARTS LIST

Jet Pump

ITEM NAME	PART NUMBER	QUANTITY
CAP,JET PUMP (Ref # 11012)	11012-3738	1
SHAFT,JET PUMP (Ref # 13107)	13107-3721	1
SHAFT-COMP,JOINT (Ref # 13234)	13234-3708	1
ELBOW (Ref # 52014)	52014-3708	1
NOZZLE-PUMP (Ref # 59136)	59136-3713	1
IMPELLER (Ref # 59256)	59256-3711	1
JOINT-BALL (Ref # 59266)	59266-3707	1
CASE-PUMP (Ref # 59336)	59336-3702	1
GRATE (Ref # 59366)	59366-3001	1
NOZZLE-STRG (Ref # 59476)	59476-3702	1
VANE-GUIDE (Ref # 59496)	59496-3702	1
BOLT,SOCKET,6X11 (Ref # 92001)	92001-3701	2
BOLT,BALL,6MM (Ref # 92001A)	92001-3703	1
BOLT,6X16 (Ref # 92002)	92002-3728	3
FITTING,HOSE (Ref # 92005)	92005-3712	1
NUT,10MM (Ref # 92015)	92015-3005	4
WASHER (Ref # 92022)	92022-567	1
SHIM,T=0.3MM (Ref # 92025)	92025-3701	AR
SHIM,T=0.5MM (Ref # 92025A)	92025-3702	AR
SHIM,T=1.0MM (Ref # 92025B)	92025-3703	AR
SHIM,T=1.5MM (Ref # 92025C)	92025-3704	AR
SHIM,T=1.0 (Ref # 92025D)	92025-3717	AR
SHIM,T=1.5 (Ref # 92025E)	92025-3718	AR
SHIM,T=2.0 (Ref # 92025F)	92025-3719	AR
BUSHING,17X25X15 (Ref # 92028)	92028-3717	1
BEARING-BALL,#63032RD (Ref # 92045)	92045-3706	2
SEAL-OIL,TCV-25476 (Ref # 92049)	92049-3711	2
RING-O,13X1.9 (Ref # 92055)	92055-1021	2
RING-O (Ref # 92055A)	92055-3706	1

1995 550 SX PARTS LIST

Jet Pump

ITEM NAME	PART NUMBER	QUANTITY
SEAL (Ref # 92093)	92093-3702	1
COLLAR,17.4X25.4X53 (Ref # 92143)	92143-3708	1
BOLT,6X125 (Ref # 92150)	92150-3784	4
BOLT-SOCKET (Ref # 120)	120R1025	4
BOLT-WP,6X12 (Ref # 156)	156R0612	1
BOLT-WP (Ref # 156A)	156R0630	2
WASHER-PLAIN,6MM (Ref # 411)	411S0600	4
WASHER-PLAIN,10MM (Ref # 411A)	411S1000	4
WASHER-SPRING,10MM (Ref # 461)	461S1000	4
PIN-DOWEL (Ref # 551)	551R0612	2