

1995 550 SX PARTS DIAGRAM

Electrical Equipment

F3181

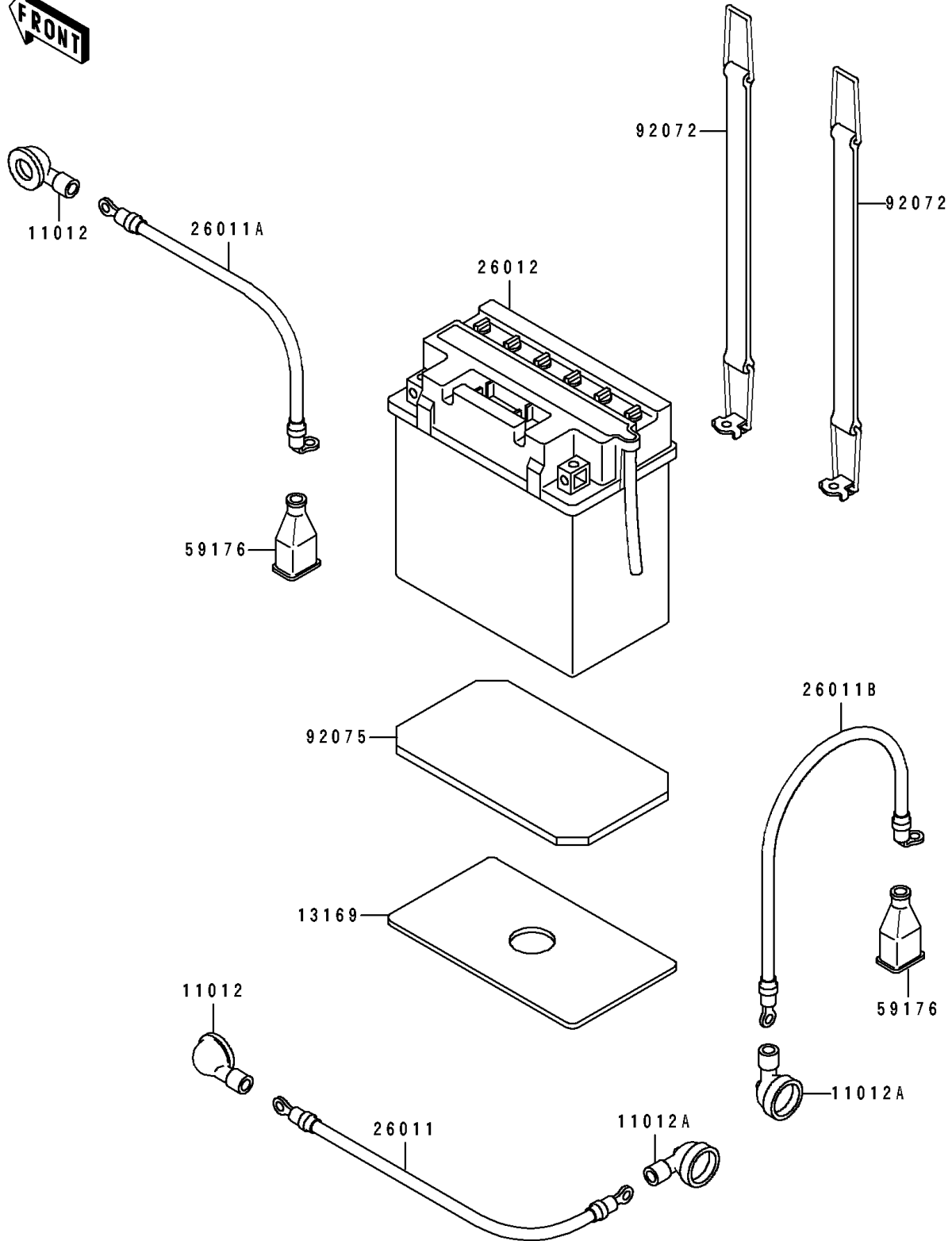

1995 550 SX PARTS LIST

Electrical Equipment

ITEM NAME	PART NUMBER	QUANTITY
CAP (Ref # 11012)	11012-3004	2
CAP,LEAD WIRE (Ref # 11012A)	11012-3726	2
PLATE,BATTERY (Ref # 13169)	13169-3014	1
WIRE-LEAD,STARTER (Ref # 26011)	26011-3005	1
WIRE-LEAD,BATTERY(-) (Ref # 26011A)	26011-3776	1
WIRE-LEAD,BATTERY(+) (Ref # 26011B)	26011-3778	1
BATTERY,YB16CL-B,12V 19AH (Ref # 26012)	26012-3707	1
CAP.,TERMINAL (Ref # 59176)	59176-501	2
BAND,BATTERY (Ref # 92072)	92072-3749	2
DAMPER,BATTERY (Ref # 92075)	92075-509	1