

1979 KD100-M4 PARTS DIAGRAM

REAR HUB/BRAKE/CHAIN

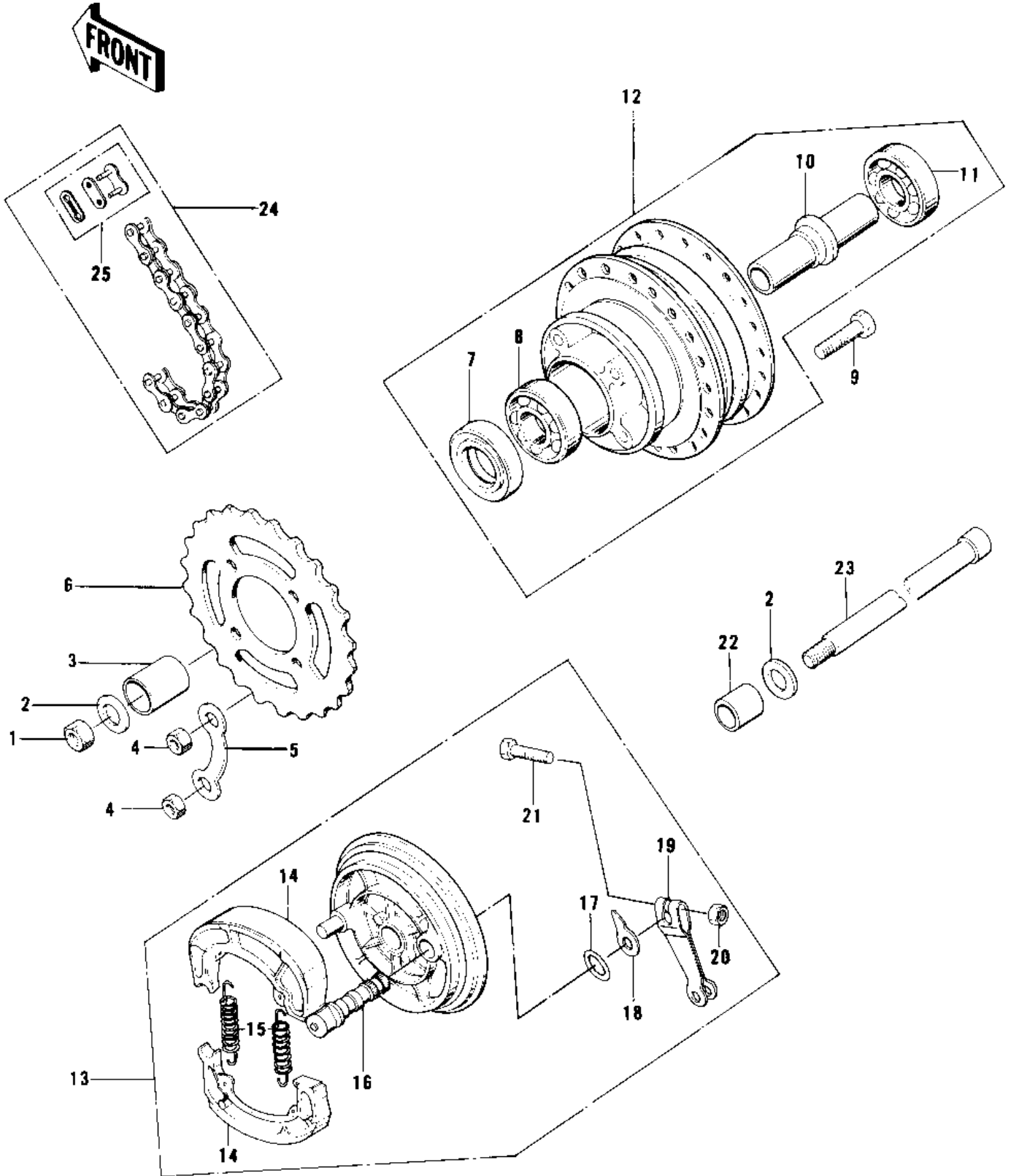

1979 KD100-M4 PARTS LIST

REAR HUB/BRAKE/CHAIN

ITEM NAME	PART NUMBER	QUANTITY
NUT-HEX-FINE (Ref # 1)	314B1200	
WASHER PLAIN 12MM (Ref # 2)	411B1200	
COLLAR,REAR AXLE (Ref # 3)	42032-044	
NUT,8MM (Ref # 4)	311B0800	
WASHER RR SPRCKT LOCK (Ref # 5)	92088-003	
REAR SPROCKET 36T (Ref # 6)	42041-022	
REAR SPROCKET 34T (Ref # 6)	42041-019	
OIL SEAL RR BRK DRUM (Ref # 7)	92052-001	
BEARING BALL #6301 (Ref # 8)	601B6301	
BOLT REAR SPROCKET (Ref # 9)	92001-021	
SPACER RR HUB BEARING (Ref # 10)	42010-003	
BEARING BALL #6301Z (Ref # 11)	601B6301Z	
DRUM-ASSY,RR BRK,BUFF (Ref # 12)	41034-1002-80	
DRUM-ASSY,RR BRK,BUFF (Ref # 12)	41034-1002-80	
PANEL-ASY,RR BRK,BUFF (Ref # 13)	42006-063-80	
SHOE-BRAKE (Ref # 14)	41048-1085	
SPRING,BRAKE SHOE (Ref # 15)	92081-1766	
CAM SHAFT,REAR BRAKE (Ref # 16)	42026-018	
"O" RING,11MM (Ref # 17)	92055-004	
INDICATOR,BKSHOE (Ref # 18)	41085-003	
LEVER,REAR BRAKE PANL (Ref # 19)	42029-027	
NUT,6MM (Ref # 20)	41072-007	
BOLT-UPSET (Ref # 21)	112G0630	
COLLAR-REAR HUB R.H (Ref # 22)	42032-002	
AXLE,12X206 (Ref # 23)	41068-1091	
CHAIN,DRIVE,EK428 96L (Ref # 24)	92057-1089	
JOINT-CHAIN (Ref # 25)	92058-1014	