

1980 KE100 PARTS DIAGRAM

CLUTCH

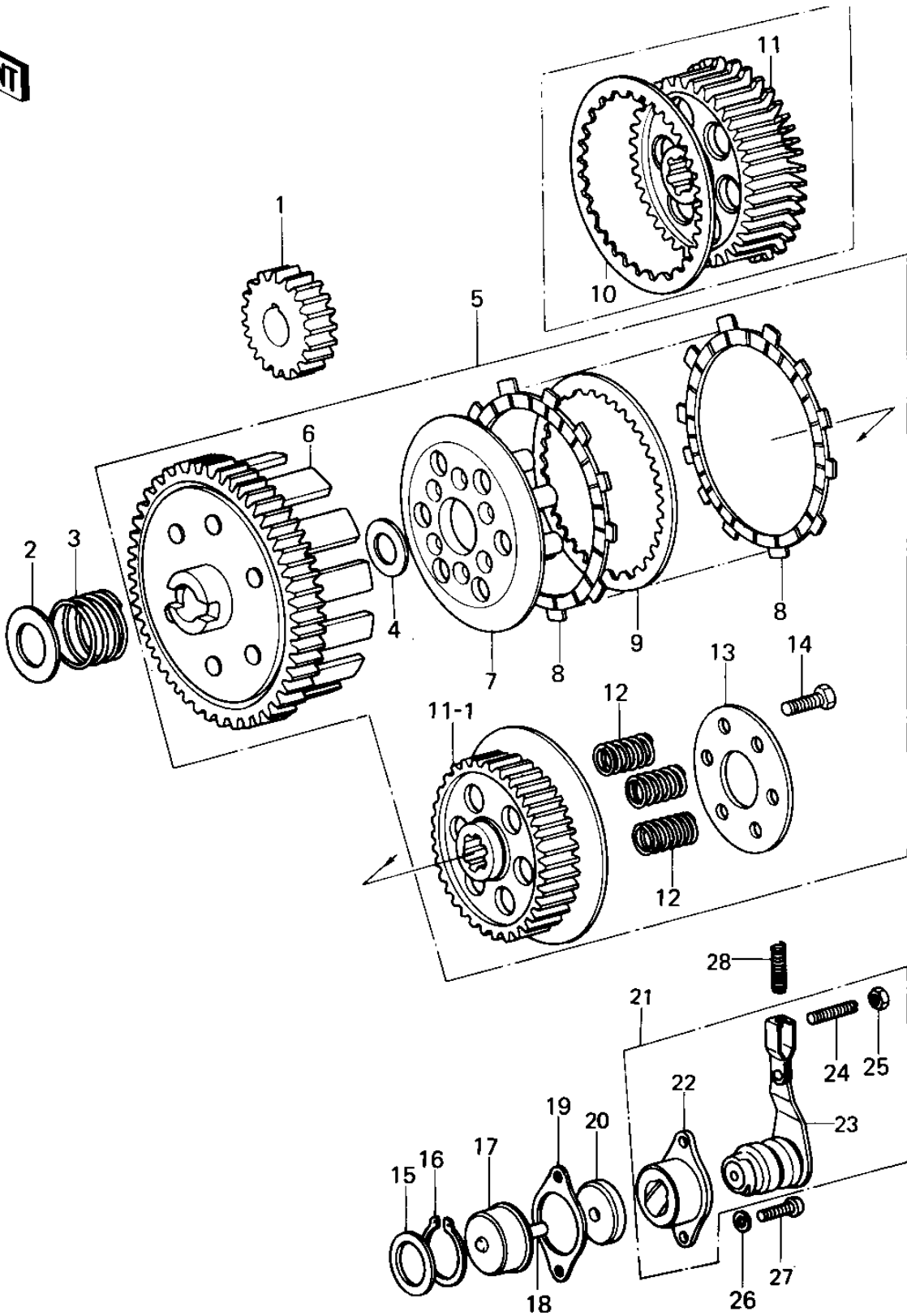

1980 KE100 PARTS LIST

CLUTCH

ITEM NAME	PART NUMBER	QUANTITY
PINION,PRIMARY (Ref # 1)	13121-032	
PINION,PRIMARY (Ref # 1)	13121-032	
WASHER PLAIN (Ref # 2)	92022-057	
SPRING CLUTCH DAMPER (Ref # 3)	92081-015	
WASHER THRUST CLUTCH (Ref # 4)	92022-054	
CLUTCH-ASSY (Ref # 5)	13081-028	
CLUTCH-ASSY (Ref # 5)	13081-028	
HOUSING CLUTCH (Ref # 6)	13095-022	
HOUSING CLUTCH (Ref # 6)	13095-022	
WHEEL,CLUTCH (Ref # 7)	13086-1002	
WHEEL,CLUTCH (Ref # 7)	13086-1002	
PLATE-FRICTION (Ref # 8)	13088-1103	
PLATE-CLUTCH,STEEL (Ref # 9)	13089-1009	
PLATE CLUTCH OUTER (Ref # 10)	13090-004	
HUB,CLUTCH (Ref # 11)	13087-1011	
HUB,CLUTCH (Ref # 11-1)	13087-1011	
SPRING CLUTCH (Ref # 12)	92081-012	
HOLDER,CLUTCH SPRING (Ref # 13)	13091-1115	
BOLT-UPSET (Ref # 14)	112G0516	
WASHER THRUST (Ref # 15)	92022-053	
CIRCLIP 16MM (Ref # 16)	480J1600	
PUSHER CLUTCH SPRING (Ref # 17)	13113-003	
PIN,DOWEL (Ref # 18)	92042-043	
GASKET,CLUTCH RELEASE (Ref # 19)	11060-1197	
OIL SEAL (Ref # 20)	92050-071	
RELEASE-ASSY-CLUTCH (Ref # 21)	13231-1008	
RELEASE-ASSY-CLUTCH (Ref # 22)	13231-1008	
RELEASE-ASSY-CLUTCH (Ref # 23)	13231-1008	
SCREW,SLOTTED,6X16 (Ref # 24)	291H0616	