

1978 KE100 PARTS DIAGRAM

ENGINE COVERS

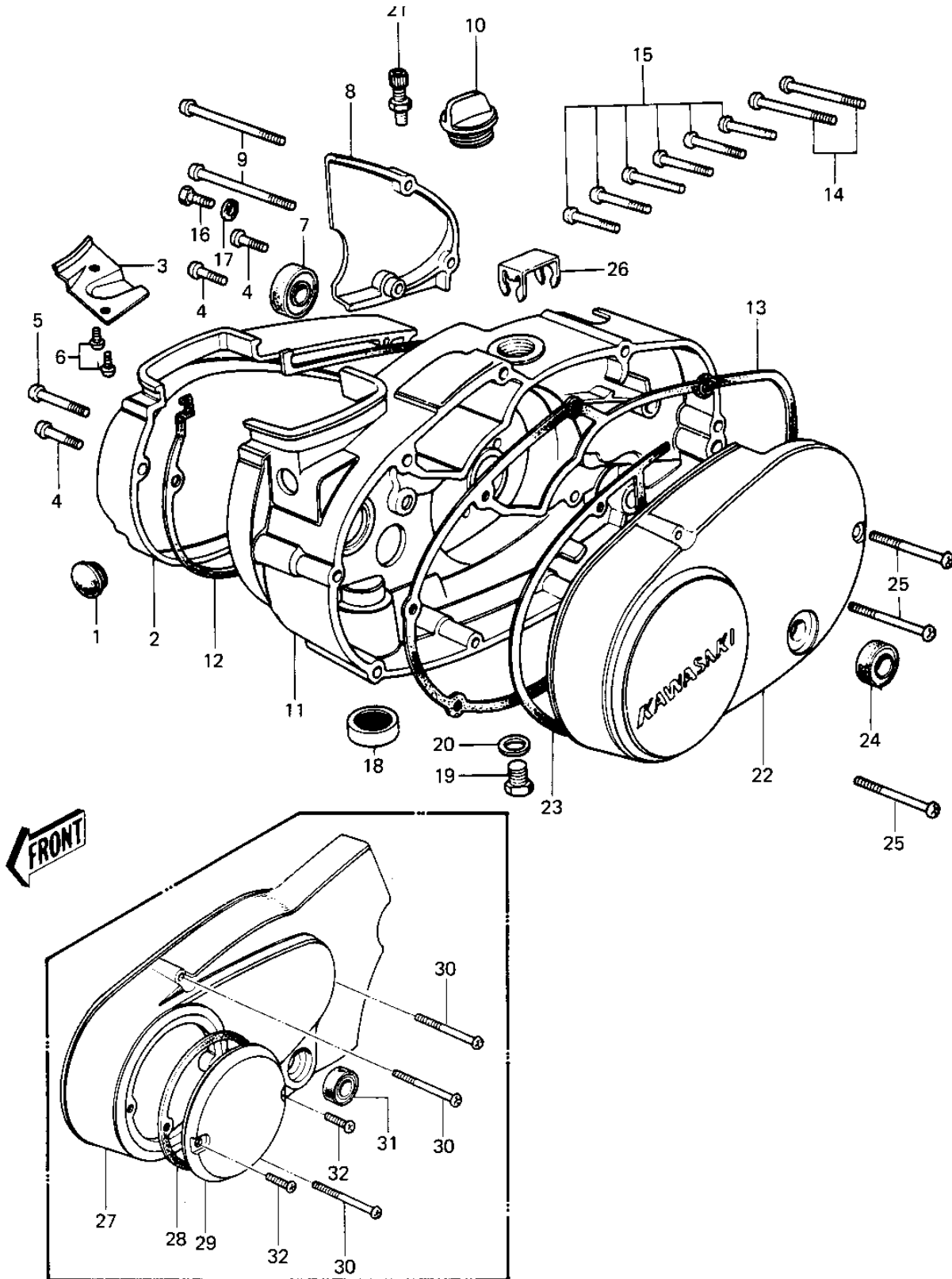

1978 KE100 PARTS LIST

ENGINE COVERS

ITEM NAME	PART NUMBER	QUANTITY
CAP CARB MOUNT HOLE (Ref # 1)	14039-001	
COVER,CARB BARREL (Ref # 2)	14030-1005	
COVER,CARB BARREL (Ref # 2)	14030-1005	
COVER,CARB BARREL (Ref # 2)	14030-1005	
COVER,CLUTCH CABLE (Ref # 3)	14025-1137	
COVER,CLUTCH CABLE (Ref # 3)	14025-1137	
SCREW PAN HEAD 6X20 (Ref # 4)	220B0620	
SCREW PAN HEAD 6X35 (Ref # 5)	220B0635	
SCREW PAN HEAD 6X12 (Ref # 6)	220B0612	
OIL SEAL TB14257 (Ref # 7)	653B142507	
COVER,OIL PUMP,BUFF (Ref # 8)	14030-050-80	
SCREW PAN HEAD 6X75 (Ref # 9)	220B0675	
FILLER,OIL (Ref # 10)	16115-018	
COVER,R.H,ENG,BARREL (Ref # 11)	14032-1017	
COVER,R.H,ENG,BARREL (Ref # 11)	14032-1017	
GASKET,CARBURETOR COV (Ref # 12)	11060-1201	
GASKET,CLUTCH COVER (Ref # 13)	11060-1198	
SCREW PAN HEAD 6X45 (Ref # 14)	220B0645	
SCREW PAN HEAD 6X30 (Ref # 15)	220B0630	
BOLT,HEX HEAD,6X14 (Ref # 16)	92001-121	
WASHER OIL PUMP BANJO (Ref # 17)	92022-077	
DRAIN,FUEL (Ref # 18)	16116-006	
PLUG OIL DRAIN (Ref # 19)	92067-001	
GASKET CHECK VALVE (Ref # 20)	92065-058	
ADJUSTER,CABLE (Ref # 21)	16002-012	
COVER,L.H.ENGINE (Ref # 22)	14031-1029	
COVER,L.H.ENGINE (Ref # 22)	14031-1029	
GASKET,GENERATOR COVE (Ref # 23)	11060-1202	
OIL SEAL SB12205 (Ref # 24)	92049-004	

1978 KE100 PARTS LIST

ENGINE COVERS

ITEM NAME	PART NUMBER	QUANTITY
SCREW PAN HEAD 6X45 (Ref # 25)	220B0645	
CLAMP,OIL PUMP CABLE (Ref # 26)	92037-1107	
COVER,GENERATOR (Ref # 27)	14031-1034	
GASKET BREAKER COVER (Ref # 28)	14050-002	
COVER-BRK POINT,CR (Ref # 29)	14027-007-79	
SCREW PAN HEAD 6X40 (Ref # 30)	220B0640	
SEAL-OIL (Ref # 31)	92049-1249	
SCREW PAN HEAD 6X12 (Ref # 32)	220B0612	