

1980 KE100 PARTS DIAGRAM

MUFFLER

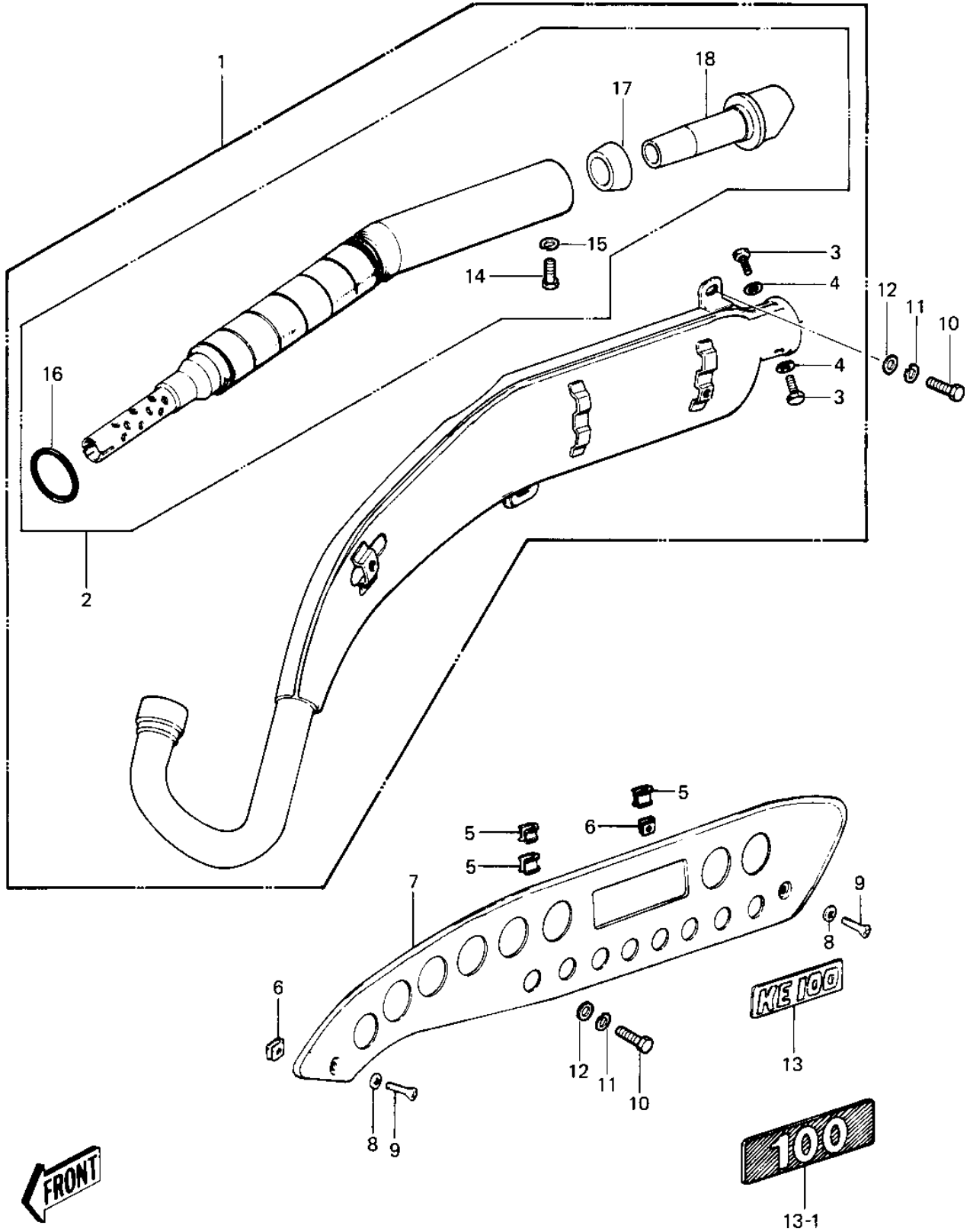

1980 KE100 PARTS LIST

MUFFLER

ITEM NAME	PART NUMBER	QUANTITY
MUFFLER (Ref # 1)	18001-1603	
MUFFLER (Ref # 1)	18001-1603	
BAFFLE TUBE (Ref # 2)	18033-070	
BOLT-UPSET 6X14 (Ref # 3)	112B0614	
WASHER OIL PUMP BANJO (Ref # 4)	92022-077	
INSULATOR (Ref # 5)	18065-007	
INSULATOR-HEAT (Ref # 6)	18065-009	
COVER,MUFFLER (Ref # 7)	18057-047	
WASHER LOCK 6MM (Ref # 8)	463H0600	
SCREW PAN HEAD 6X12 (Ref # 9)	220E0612	
BOLT-SMALL-UPSET,8X16 (Ref # 10)	115G0816	
WASHER SPRING 8MM (Ref # 11)	461F0800	
WASHER PLAIN 8MM (Ref # 12)	411B0800	
EMBLEM,SIDE COVER (Ref # 13)	56018-222	
EMBLEM,MUFFLER COVER (Ref # 13-1)	56018-1039	
BOLT-UPSET 6X14 (Ref # 14)	112B0614	
WASHER LOCK 6MM (Ref # 15)	464H0600	
'O' RING (Ref # 16)	92093-1031	
BUSHING,RUBBER (Ref # 17)	92093-1009	
ARRESTOR CAP (Ref # 18)	59156-1005	