

1979 KE100 PARTS DIAGRAM

SWING ARM/SHOCK ABSORBERS

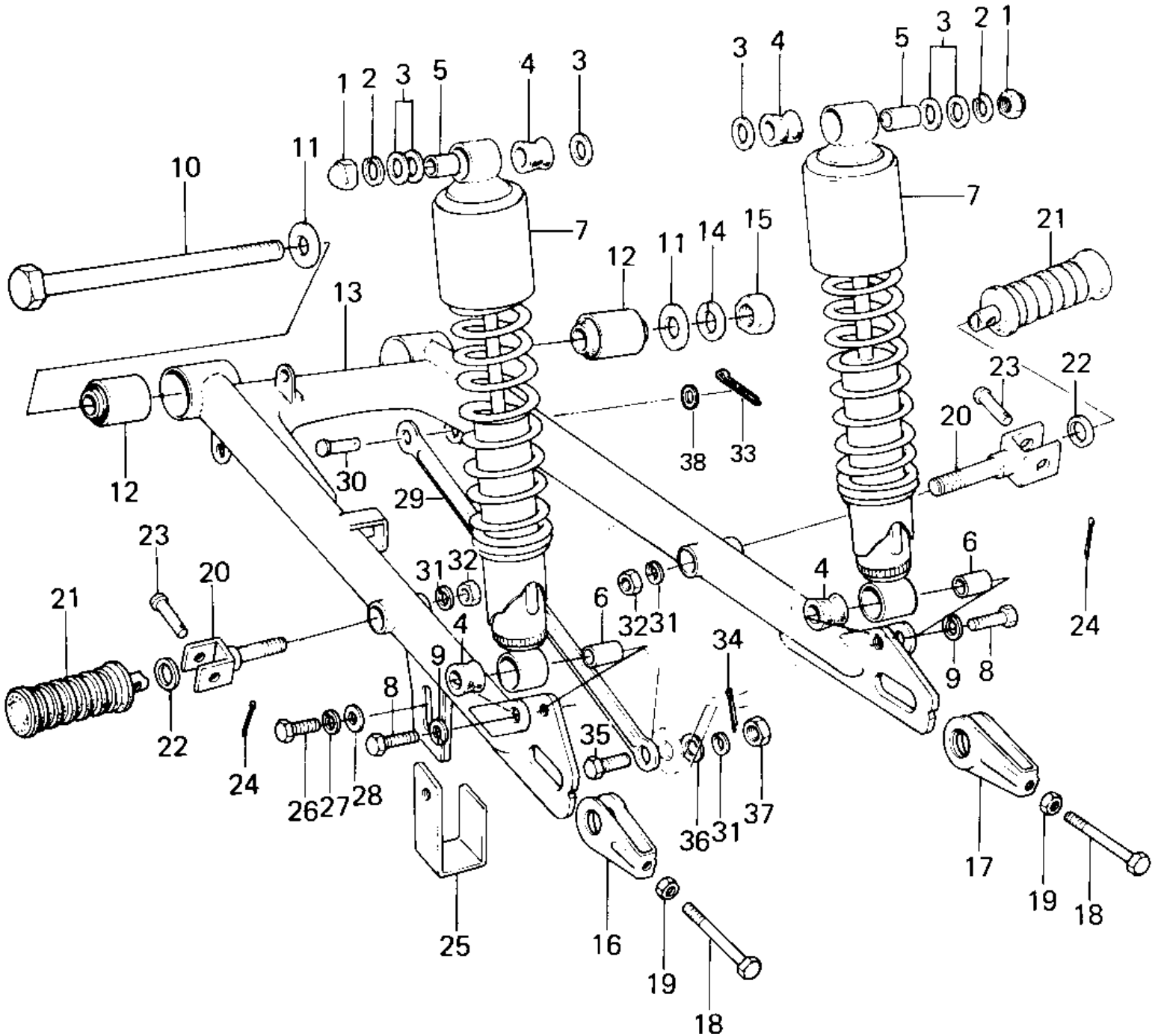

1979 KE100 PARTS LIST

SWING ARM/SHOCK ABSORBERS

ITEM NAME	PART NUMBER	QUANTITY
NUT 12MM (Ref # 1)	92020-014	
WASHER SPRING 12MM (Ref # 2)	461F1200	
WASHER PLAIN 12MM (Ref # 3)	410B1200	
BUSHING,RUBBER (Ref # 4)	92075-1020	
BUSHING,SHOCKABSORBER (Ref # 5)	92027-1063	
BUSH SHCK ABS PVT SFT (Ref # 6)	45016-003	
SHOCK ABSBR RR (Ref # 4~7)	45014-074	
SHOCK ABSBR RR (Ref # 4~7)	45014-1122	
SHOCK ABSBR RR (Ref # 4~7)	45014-1063	
SHOCK ABSBR RR (Ref # 4~7)	45014-1124	
BOLT HEX HEAD 10X35 (Ref # 8)	113N1035	
WASHER SPRING 10MM (Ref # 9)	461F1000	
SHAFT-SWING ARM PIVOT (Ref # 10)	33032-034	
WASHER PLAIN 12MM (Ref # 11)	410B1200	
BUSH SWING ARM SHAFT (Ref # 12)	92092-005	
ARM-SWINGING (Ref # 13)	33001-047	
WASHER SPRING 12MM (Ref # 14)	461F1200	
NUT-HEX-FINE (Ref # 15)	314B1200	
ADJUSTER-CHAIN,L.H. (Ref # 16)	33040-045	
ADJUSTER-CHAIN,R.H. (Ref # 17)	33040-046	
BOLT,8X50 (Ref # 18)	92001-1399	
BOLT,8X50 (Ref # 18)	92001-1399	
NUT 8MM (Ref # 19)	318B0800	
BAR,FOOTREST (Ref # 20)	34029-010	
RUBBER,FOOTREST (Ref # 21)	92076-027	
WASHER-PLAIN (OPT) (Ref # 22)	92022-199	
PIN (Ref # 23)	92043-1464	
PIN,COTTER,2.0X12 (Ref # 24)	550D2012	
GUARD-CHAIN (Ref # 25)	55020-007	

1979 KE100 PARTS LIST

SWING ARM/SHOCK ABSORBERS

ITEM NAME	PART NUMBER	QUANTITY
BOLT, HEX HEAD, 8X16 (Ref # 26)	114B0816	
WASHER SPRING 8MM (Ref # 27)	461F0800	
WASHER PLAIN 8MM (Ref # 28)	411B0800	
TORQUE LINK-RR BRAKE (Ref # 29)	43007-028	
PIN REAR TORQUE LINK (Ref # 30)	43009-001	
WASHER SPRING 10MM (Ref # 31)	461F1000	
NUT 10MM (Ref # 32)	315B1000	
PIN COTTER 2.5X16 (Ref # 33)	550D2516	
PIN COTTER 2.0X15 (Ref # 34)	550D2015	
BOLT HEX HEAD 10X25 (Ref # 35)	92003-003	
WASHER PLAIN 10MM (Ref # 36)	410B1000	
NUT,10MM (Ref # 37)	314B1000	
WASHER PLAIN 10MM (Ref # 38)	410B1000	