

1977 KE100 PARTS DIAGRAM

SIDE COVER/OIL TANK

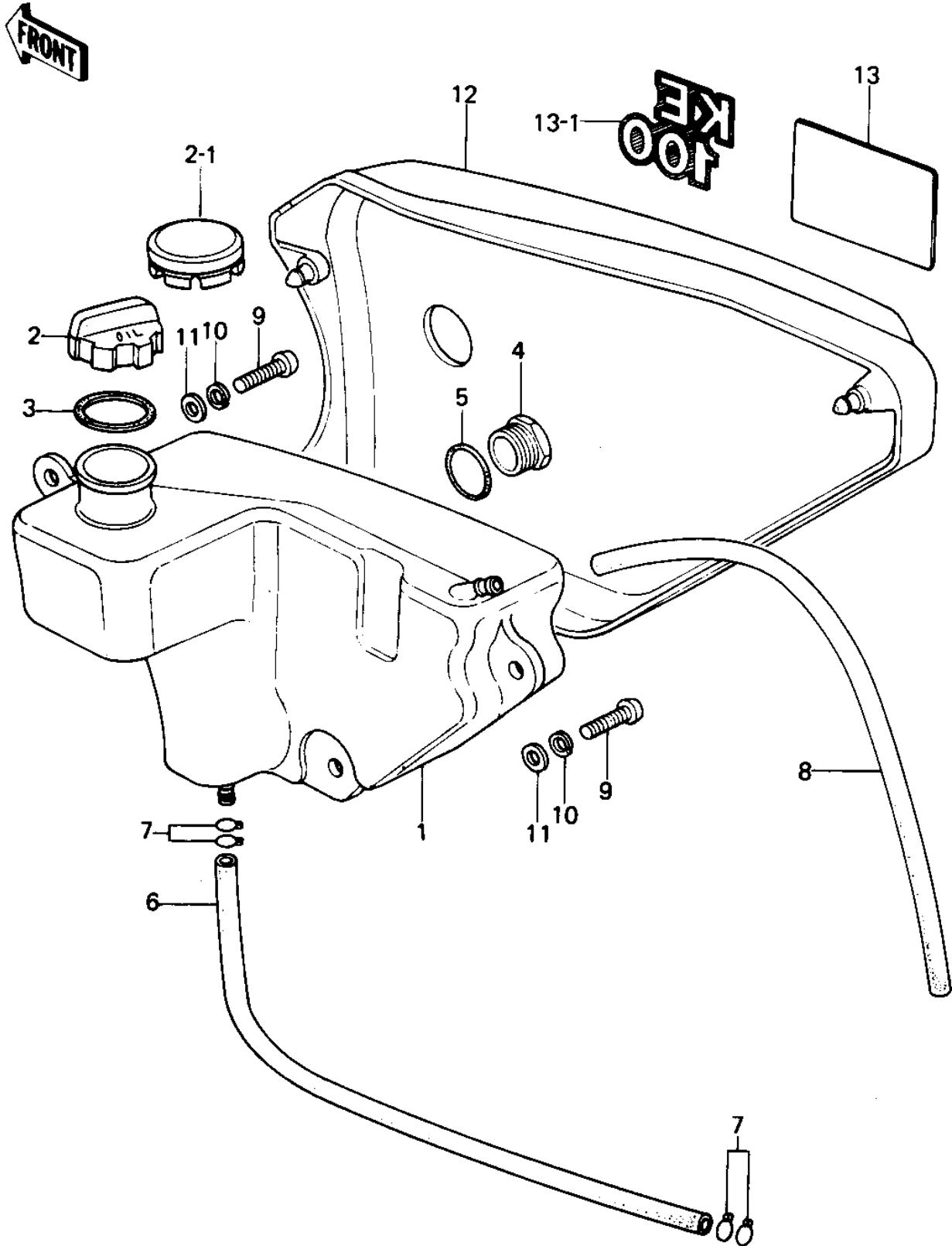

1977 KE100 PARTS LIST

SIDE COVER/OIL TANK

ITEM NAME	PART NUMBER	QUANTITY
TANK-OIL (Ref # 1)	52001-029	
TANK,OIL (Ref # 1)	52001-1003	
CAP-OIL TANK (Ref # 2)	52003-019	
CAP-OIL TANK (Ref # 2-1)	51049-1004	
GASKET-OIL TANK CAP (Ref # 3)	92065-085	
GUAGE-OIL LEVEL (Ref # 4)	52015-002	
"O" RING,20MM (Ref # 5)	92055-051	
PIPE-FUEL (Ref # 6)	92059-073	
CLAMP FUEL PIPE (Ref # 7)	92037-010	
TUBE-VINYL,5X280 (Ref # 8)	700Q05280	
SCREW PAN HEAD 6X16 (Ref # 9)	220B0616	
WASHER SPRING 6MM (Ref # 10)	461F0600	
WASHER 6.5X20X1.6T (Ref # 11)	92022-125	
COVER,RH SIDE,C.BLUE (Ref # 12)	36007-049-4C	
COVER,RH SIDE,C.COPPR (Ref # 12)	36007-049-4D	
COVER,RH SIDE,P.RED (Ref # 12)	36007-049-4P	
COVER,RH SIDE,P.GREEN (Ref # 12)	36007-049-4Q	
COVER,RH SIDE,C.C.BLU (Ref # 12)	36007-049-4S	
COVER,RH SIDE,S.F.YEL (Ref # 12)	36007-049-7H	
COVER,L.H SIDE,S.GREN (Ref # 12)	36001-1065-6P	
COVER,L.H SIDE,S.YELL (Ref # 12)	36001-1065-6R	
COVER,LH SIDE B GREEN (Canada) (Ref # 12)	36001-1065-6J	
COVER,R.H.SIDE,F.RED (Ref # 12)	36001-1065-6L	
COVER,R.H.SIDE,B.BLUE (Ref # 12)	36001-1065-6K	
EMBLEM,SIDE COVER (Ref # 13)	56018-222	
EMBLEM,SIDE COVER (Ref # 13-1)	56018-1038	