

1980 KE100 PARTS DIAGRAM

SEAT/CHAIN COVER

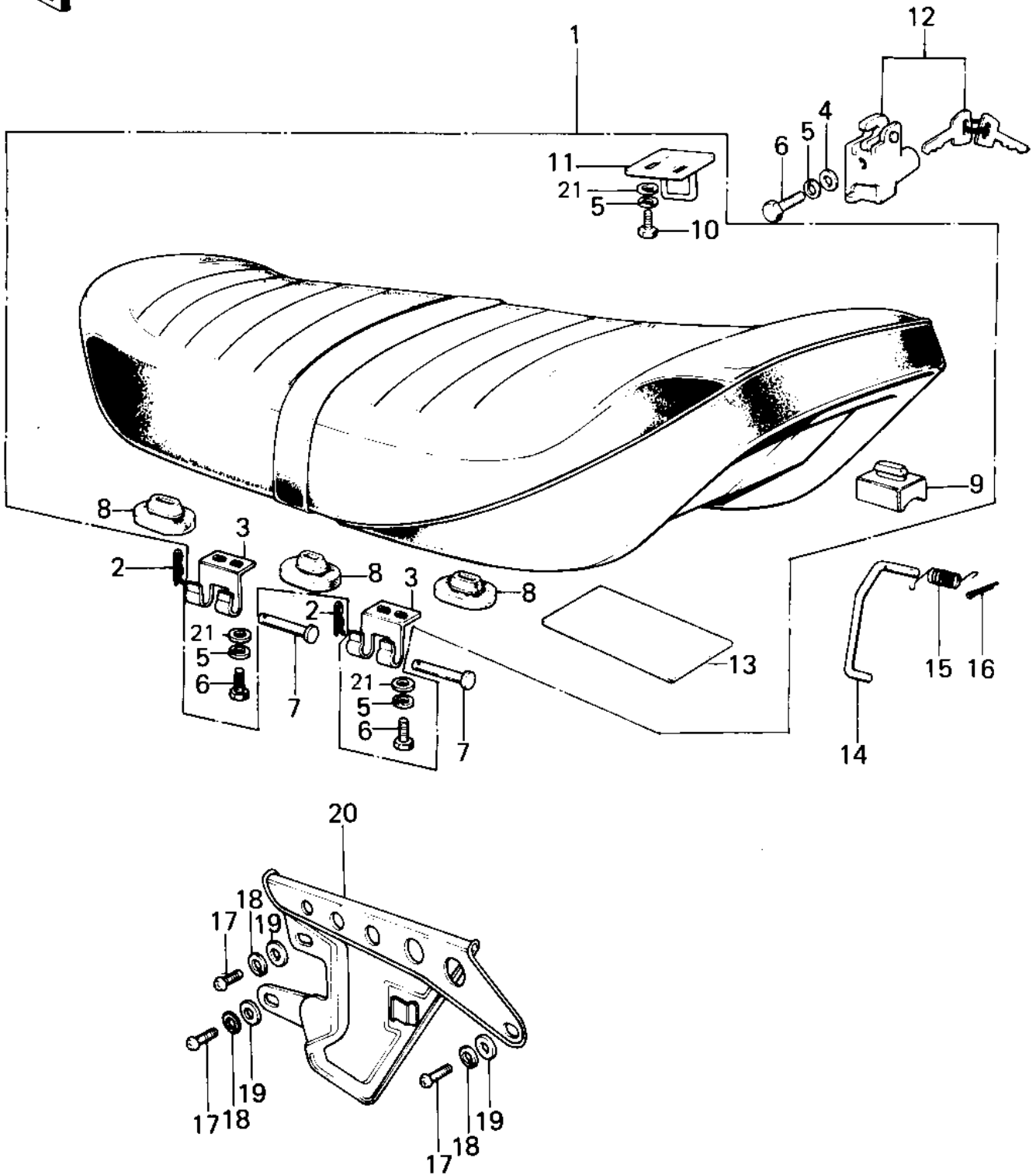

1980 KE100 PARTS LIST

SEAT/CHAIN COVER

ITEM NAME	PART NUMBER	QUANTITY
SEAT ASSY (Ref # 1)	53002-1015	
SEAT ASSY,DUAL (Ref # 1)	53002-1016	
SEAT ASSY,DUAL (Ref # 1)	53002-1016	
SEAT ASSY (Ref # 1)	53002-1007	
PIN,SNAP (Ref # 2)	554A0600	
HINGE,BLACK (Ref # 3)	53009-017-10	
WASHER PLAIN 6MM (Ref # 4)	410B0600	
WASHER SPRING 6MM (Ref # 5)	461F0600	
BOLT-UPSET,6X12 (Ref # 6)	112G0612	
PIN (Ref # 7)	53011-002	
DAMPER RUBB DUAL SEAT (Ref # 8)	92075-023	
DAMPER RUBBER,SEAT (Ref # 9)	92075-216	
BOLT-UPSET 6X14 (Ref # 10)	112B0614	
HOOK, SEAT (Ref # 11)	53008-021	
LOCK ASSY,SEAT (Ref # 12)	53045-014	
DAMPER RUBBER,BATTERY (Ref # 13)	92075-224	
STAND,SEAT (Ref # 14)	53054-003	
SPRING,SEAT HOOK (Ref # 15)	53055-001	
PIN COTTER 2.0X15 (Ref # 16)	550D2015	
SCREW PAN HEAD 6X12 (Ref # 17)	220B0612	
WASHER SPRING 6MM (Ref # 18)	461F0600	
WASHER PLAIN 6MM (Ref # 19)	411B0600	
CASE-CHAIN,FR BLACK (Ref # 20)	36014-043-21	
WASHER PLAIN 6MM (Ref # 21)	411B0600	