

1978 KE100 PARTS DIAGRAM

HEADLIGHT

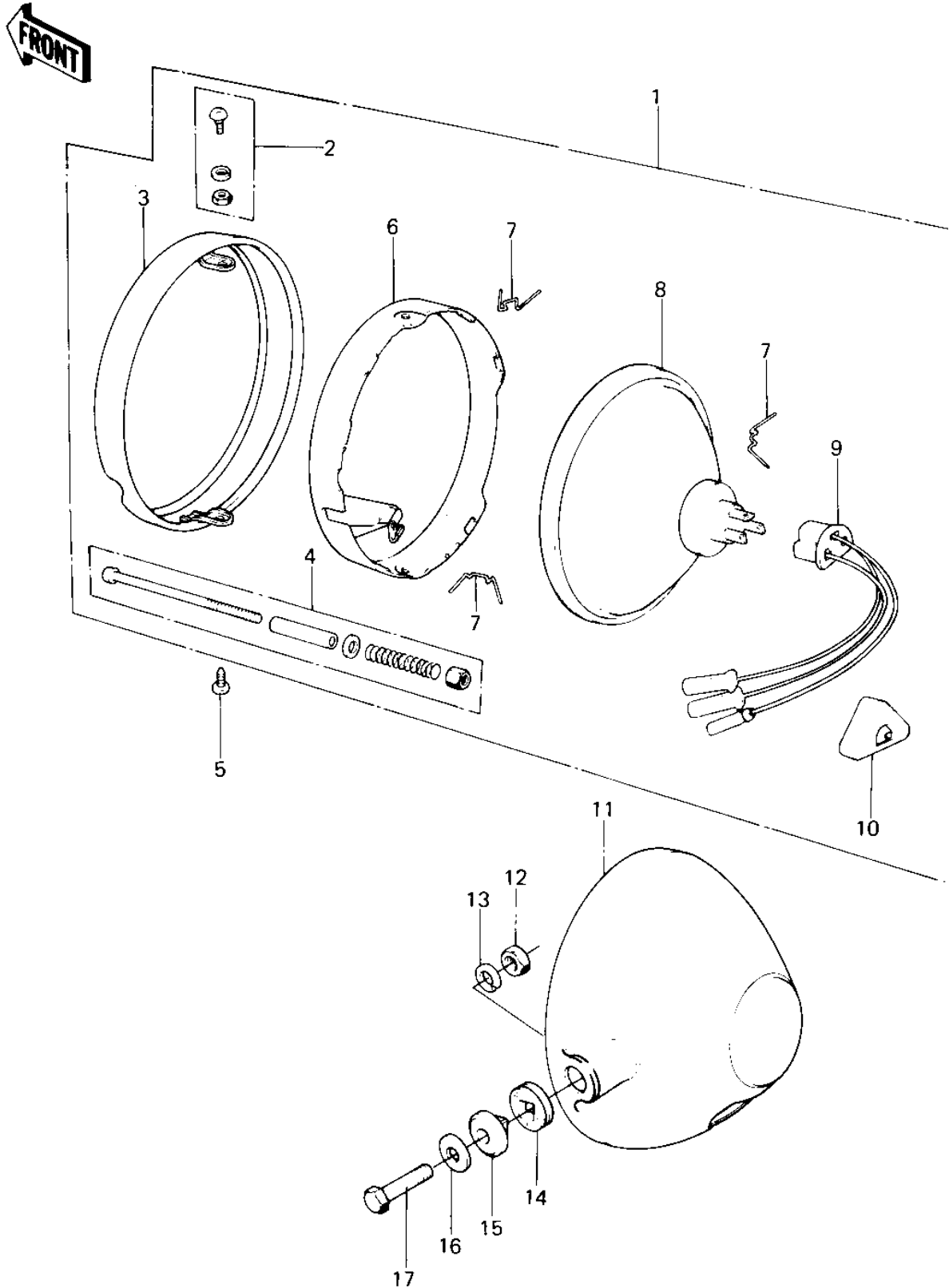

1978 KE100 PARTS LIST

HEADLIGHT

ITEM NAME	PART NUMBER	QUANTITY
LAMP UNIT,HEAD (Ref # 1)	23003-024	
SCREW SET,LENS UNIT (Ref # 2)	23013-007	
RIM,HEAD LAMP (Ref # 3)	23006-042	
SCREW ASSY,FOCUS AJST (Ref # 4)	23013-5001	
SCREW ASSY,FOCUS AJST (Ref # 4)	23013-5001	
SCREW,PAN HEAD,5X14 (Ref # 5)	23019-025	
RETAINER,SEALED BEAM (Ref # 6)	23072-002	
CLAMP,HEAD LAMP LENS (Ref # 7)	23009-015	
SEALED BEAM UNIT (Ref # 8)	23007-055	
SOCKET ASSY,HD LIGHT (Ref # 9)	23008-044	
SOCKET ASSY,HD LIGHT (Ref # 9)	23008-044	
COVER,HD LAMP SOCKET (Ref # 10)	23081-001	
BODY,HEAD LAMP,BLACK (Ref # 11)	23005-049-21	
NUT,10MM (Ref # 12)	314B1000	
WASHER SPRING 10MM (Ref # 13)	461F1000	
DAMPER RUBBER (Ref # 14)	23066-011	
COLLAR (Ref # 15)	23052-005	
WASHER-PLAIN,10MM (Ref # 16)	411D1000	
BOLT,HEX HEAD,10X30 (Ref # 17)	92007-041	
BOLT HEX HEAD 10X28 (Ref # 17)	113N1028	