

1978 KM100-A3 PARTS DIAGRAM

GEAR CHANGE DRUM & FORKS (KM100-A6/A7)

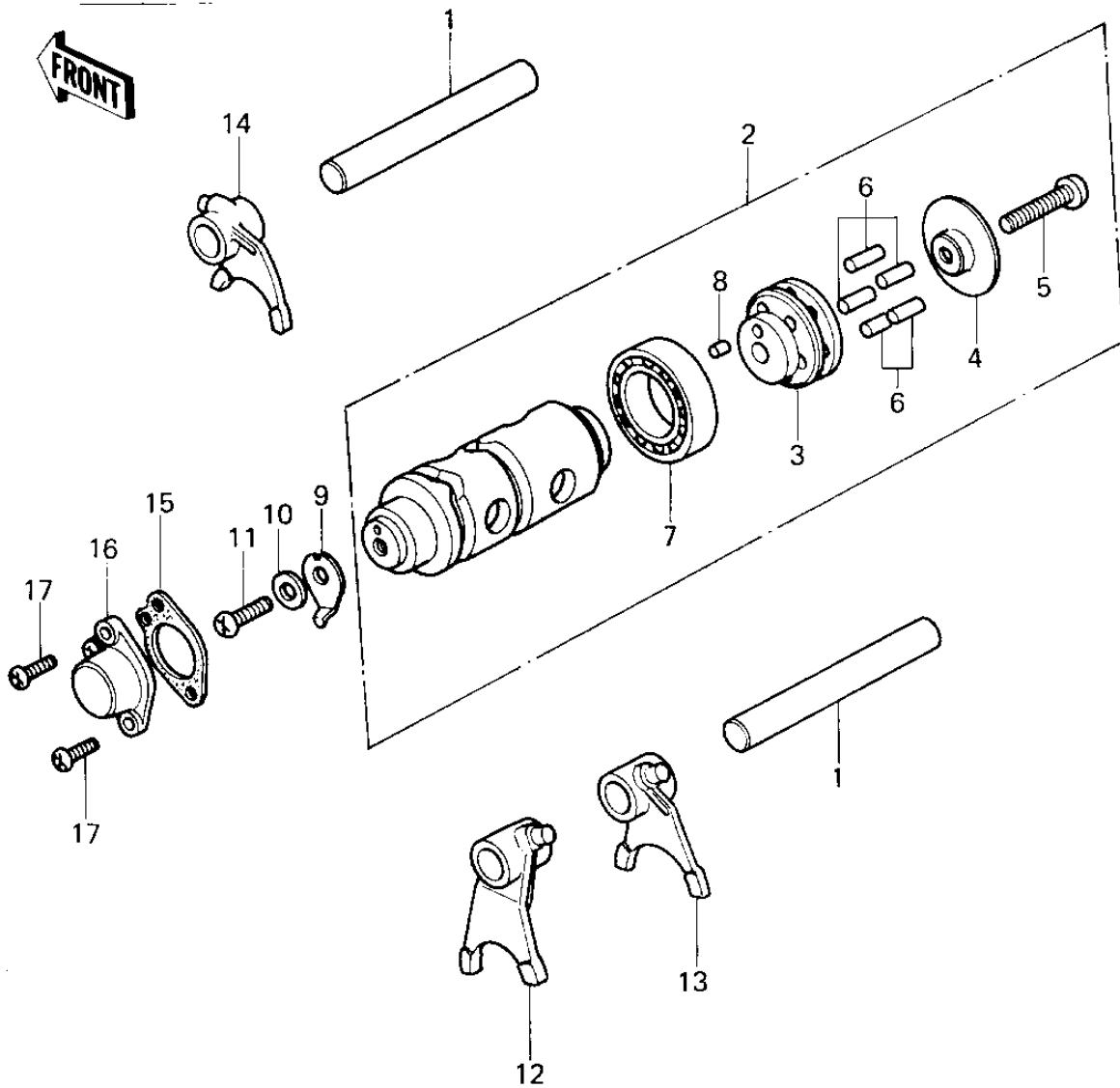

1978 KM100-A3 PARTS LIST

GEAR CHANGE DRUM & FORKS (KM100-A6/A7)

ITEM NAME	PART NUMBER	QUANTITY
PISTON 0.020' O.S (Ref # 1)	13029-014	
DRUM-ASSY-CHANGE (Ref # 2)	13239-5001	
DRUM ASSY,GEAR CHANGE (Ref # 2)	13239-1034	
HOLDER,GEAR CHANG DRM (Ref # 3)	13091-1059	
HOLDER (Ref # 3)	13091-1077	
PLATE CHANGE DRUM PIN (Ref # 4)	13142-008	
HOLDER,CHANGE DRUM (Ref # 4)	13142-014	
SCREW PAN HEAD 6X30 (Ref # 5)	220B0630	
BOLT,SOCKET,6X30 (Ref # 5)	120P0630	
PIN,GEAR CHANGE DRUM (Ref # 6)	92042-042	
BEARING,BALL,#6905 (Ref # 7)	92045-036	
BEARING BALL #6004 (Ref # 7)	601B6004	
PIN-DOWEL,4X6 (Ref # 8)	610A0406	
ROTOR,NEUTRAL INDICTR (Ref # 9)	21007-1003	
WASHER PLAIN 6MM (Ref # 10)	410B0600	
SCREW PAN HEAD 6X16 (Ref # 11)	220B0616	
SHIFT FORK,LOW&2ND (Ref # 12)	13140-1026	
SHIFT FORK,3RD (Ref # 13)	13140-1027	
SHIFT FORK,4TH&TOP (Ref # 14)	13140-1028	
GASKET NEUTRAL SWITCH (Ref # 15)	13146-002	
SWITCH,NEUTRAL (Ref # 16)	13151-1002	
SCREW PAN HEAD 6X16 (Ref # 17)	220B0616	