

1977 KM100-A2 PARTS DIAGRAM

CARBURETOR (KM100-A1-A4)

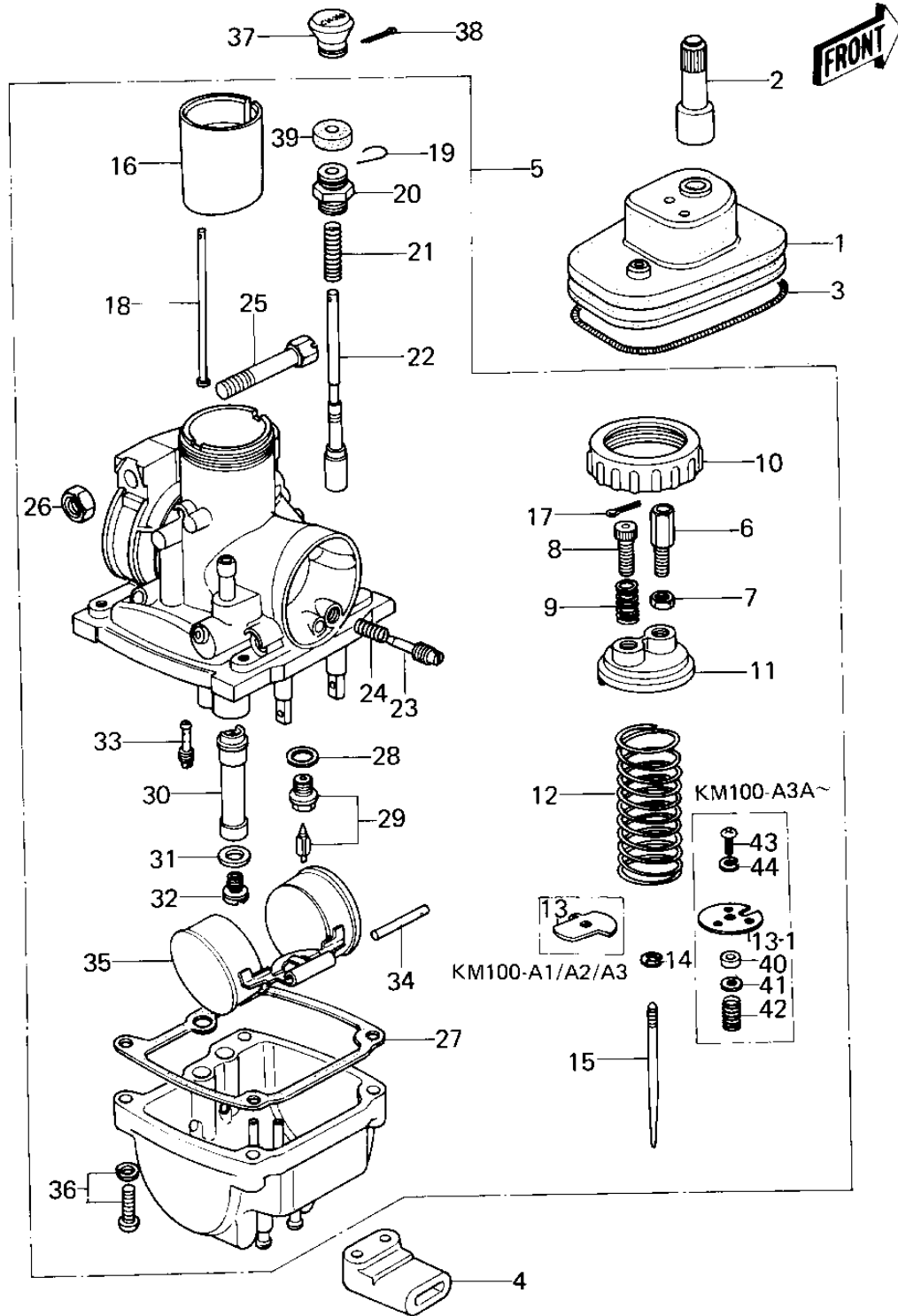

1977 KM100-A2 PARTS LIST

CARBURETOR (KM100-A1-A4)

ITEM NAME	PART NUMBER	QUANTITY
CAP,CARBURETOR (Ref # 1)	14038-035	
PLUG,CARBURETOR CAP (Ref # 2)	16147-001	
SPRING COIL (Ref # 3)	92081-047	
GROMMET,OVER FLOW (Ref # 4)	16136-007	
CARBURETOR ASSY (Ref # 5)	16001-264	
CARBURETOR ASSY (Ref # 5)	16001-1043	
ADJUSTER,CABLE (Ref # 6)	16002-017	
NUT CABLE ADJUST LOCK (Ref # 7)	16003-004	
SCREW,THROTTLE STOP (Ref # 8)	16021-002	
SPRING THR STOP SCREW (Ref # 9)	16022-005	
CAP MIXING CHAMBER (Ref # 10)	16004-010	
TOP MIXING CHAMBER (Ref # 11)	16005-005	
SPRING THROTTLE VALVE (Ref # 12)	16006-013	
SPRING SEAT,THRTL TL (Ref # 13)	16007-020	
SPRING SEAT, THROTTLE VALVE (Ref # 13 1)	13169-1105	
CIRCLIP (Ref # 14)	16008-010	
JET NEEDLE 4EJ7 (Ref # 15)	16009-059	
JET NEEDLE 4EJ12 (Ref # 15)	16009-1012	
VALVE, THROTTLE CA, 2.0 (Ref # 16)	16025-057	
VALVE, THROTTLE CA, 2.0 (Ref # 16)	16025-1013	
PIN COTTER 1.2X10 (Ref # 17)	550D1210	
ROD,THROTTLE VLV STP (Ref # 18)	16024-012	
CIRCLIP (Ref # 19)	92037-1077	
UNAVAILABLE IN PRICE BOOK (Ref # 19)	92037 1077	
CAP,STARTER PLUNGER (Ref # 20)	16012-021	
SPRING,STARTER PLUNGR (Ref # 21)	16013-010	
PLUNGER,STARTER (Ref # 22)	16016-012	
SCREW PILOT AIR ADJST (Ref # 23)	16014-002	
SPRING-THR STOP SCREW (Ref # 24)	16022-007	

1977 KM100-A2 PARTS LIST

CARBURETOR (KM100-A1-A4)

ITEM NAME	PART NUMBER	QUANTITY
SCREW CLAMP (Ref # 25)	16010-004	
NUT 6MM (Ref # 26)	311B0600	
NUT,6M/M (Ref # 26)	92015-1026	
GASKET,FLOAT CHAMBER (Ref # 27)	16019-021	
WASHER VALVE SEAT (Ref # 28)	16029-002	
FLOAT VALVE ASSY (Ref # 29)	16030-001	
NEEDLE JET O-Z (Ref # 30)	16017-068	
NEEDLE JET,O-O (Ref # 30)	16017-1016	
WASHER MAIN JET (Ref # 31)	16034-001	
MAIN JET,#77.5R (Ref # 32)	92063-1032	
MAIN JET NO 72.5R (Ref # 32)	92063-108	
MAIN JET NO 75R (Ref # 32)	92063-109	
MAIN JET, #A80 (Ref # 32)	92063-1030	
MAIN JET NO 82.5R (Ref # 32)	92063-124	
MAIN JET, #A80 (Ref # 32)	92063-1030	
MAIN JET NO 75R (Ref # 32)	92063-109	
MAIN JET,#77.5R (Ref # 32)	92063-1032	
MAIN JET NO 82.5R (Ref # 32)	92063-124	
MAIN JET NO 85R (Ref # 32)	92063-093	
PILOT JET #17.5 ISO (Ref # 33)	92064-020	
PILOT JET,#A15 (Ref # 33)	92064-1018	
FLOAT PIN (Ref # 34)	16032-003	
FLOAT (Ref # 35)	16031-015	
SCREW-FLOAT CHAMBER (Ref # 36)	16033-012	
KNOB,CARBURETOR (Ref # 37)	92077-022	
PIN COTTER 1.6X15 (Ref # 38)	550D1615	
CAP,STARTER PLUNGER (Ref # 39)	16036-012	
RING,JET NEEDLE (Ref # 40)	92027-1103	
WASHER,THROTTLE VALVE (Ref # 41)	92022-1024	