

1981 KM100 PARTS DIAGRAM

CARBURETOR (KM100-A6/A7)

E1611-0048

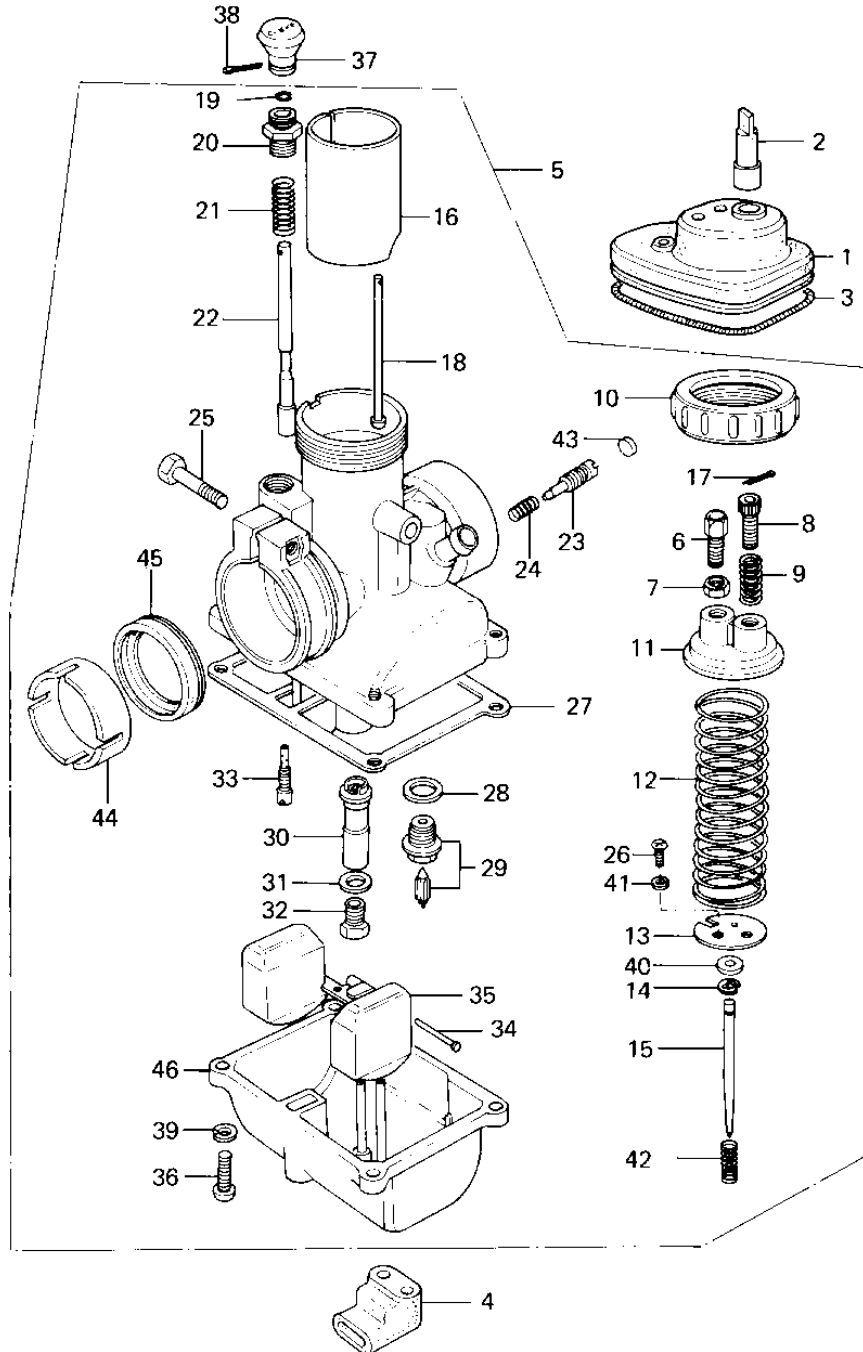

1981 KM100 PARTS LIST

CARBURETOR (KM100-A6/A7)

ITEM NAME	PART NUMBER	QUANTITY
CAP,CARBURETOR (Ref # 1)	14038-035	1
PLUG,CARBURETOR CAP (Ref # 2)	16147-001	1
SPRING COIL (Ref # 3)	92081-047	1
GROMMET,OVERFLOW (Ref # 4)	92071-1024	1
CARBURETOR ASSY (Ref # 5)	16001-1185	1
CABLE ADJUSTER (Ref # 6)	16002-1004	1
NUT,CABLE ADJSTR LOCK (Ref # 7)	92015-1092	1
THROTTLE ADJUSTER (Ref # 8)	16021-1021	1
SPRING,THROTTLE ADJST (Ref # 9)	92081-1232	1
CAP,MIXING CHAMBER (Ref # 10)	16004-1007	1
TOP,MIXING CHAMBER (Ref # 11)	16005-1010	1
SPRING,THROTTLE VALVE (Ref # 12)	92081-1234	1
SPRING SEAT,THR VALVE (Ref # 13)	13169-1223	1
CIRCLIP (Ref # 14)	92037-1167	1
JET NEEDLE,#4D21 (Ref # 15)	16009-1043	1
VALVE,THROTTLE CA.3.0 (Ref # 16)	16025-1036	1
PIN COTTER 1.2X10 (Ref # 17)	550D1210	1
ROD,THR VALVE STOP (Ref # 18)	46102-1014	1
CLAMP (Ref # 19)	92037-1166	1
CAP,STARTER PLUNGER (Ref # 20)	16012-1007	1
SPRING,STARTER PLUNGR (Ref # 21)	92081-1233	1
PLUNGER,STARTER (Ref # 22)	16016-1010	1
SCREW,PILOT AIR ADJST (Ref # 23)	16014-1022	1
SPRING,PILOT AIR SCRW (Ref # 24)	92081-1202	1
BOLT,CARB MOUNT (Ref # 25)	92001-1304	1
SCREW-PAN-HEAD 3X6 (Ref # 26)	220B0306	1
GASKET,FLOAT CHAMBER (Ref # 27)	11009-1174	1
GASKET,FLOAT VALVE (Ref # 28)	11009-1160	1
FLOAT VALVE ASSY (Ref # 29)	16031-1010	1

1981 KM100 PARTS LIST

CARBURETOR (KM100-A6/A7)

ITEM NAME	PART NUMBER	QUANTITY
NEEDLE JET,#80 (Ref # 30)	16017-1043	1
WASHER,PLAIN (Ref # 31)	92022-1167	1
MAIN JET,#82 (Ref # 32)	92063-1045	1
MAIN JET,#80 (Ref # 32)	92063-1065	(1
MAIN JET,#84 (Ref # 32)	92063-1066	(1
PILOT JET,#38 (Ref # 33)	92064-1027	1
PIN (Ref # 34)	92043-1066	1
FLOAT (Ref # 35)	16031-1009	1
SCREW-PAN-CROS (Ref # 36)	220B0414	4
KNOB,CARBURETOR (Ref # 37)	92077-022	1
PIN COTTER 1.6X15 (Ref # 38)	550D1615	1
WASHER SPRING 4MM (Ref # 39)	461F0400	4
RING,JET NEEDLE (Ref # 40)	92027-1236	1
WASHER SPRING 3MM (Ref # 41)	461F0300	1
SPRING, JET NEEDLE (Ref # 42)	92081-1203	1
PLUG,PILOT SCREW (Ref # 43)	92066-1051	1
INSULATOR,CARBURETOR (Ref # 44)	16073-1010	1
SEAL,INSULATOR (Ref # 45)	92093-1060	1