

# 1981 KM100 PARTS DIAGRAM

## FRAME/FRAME FITTINGS

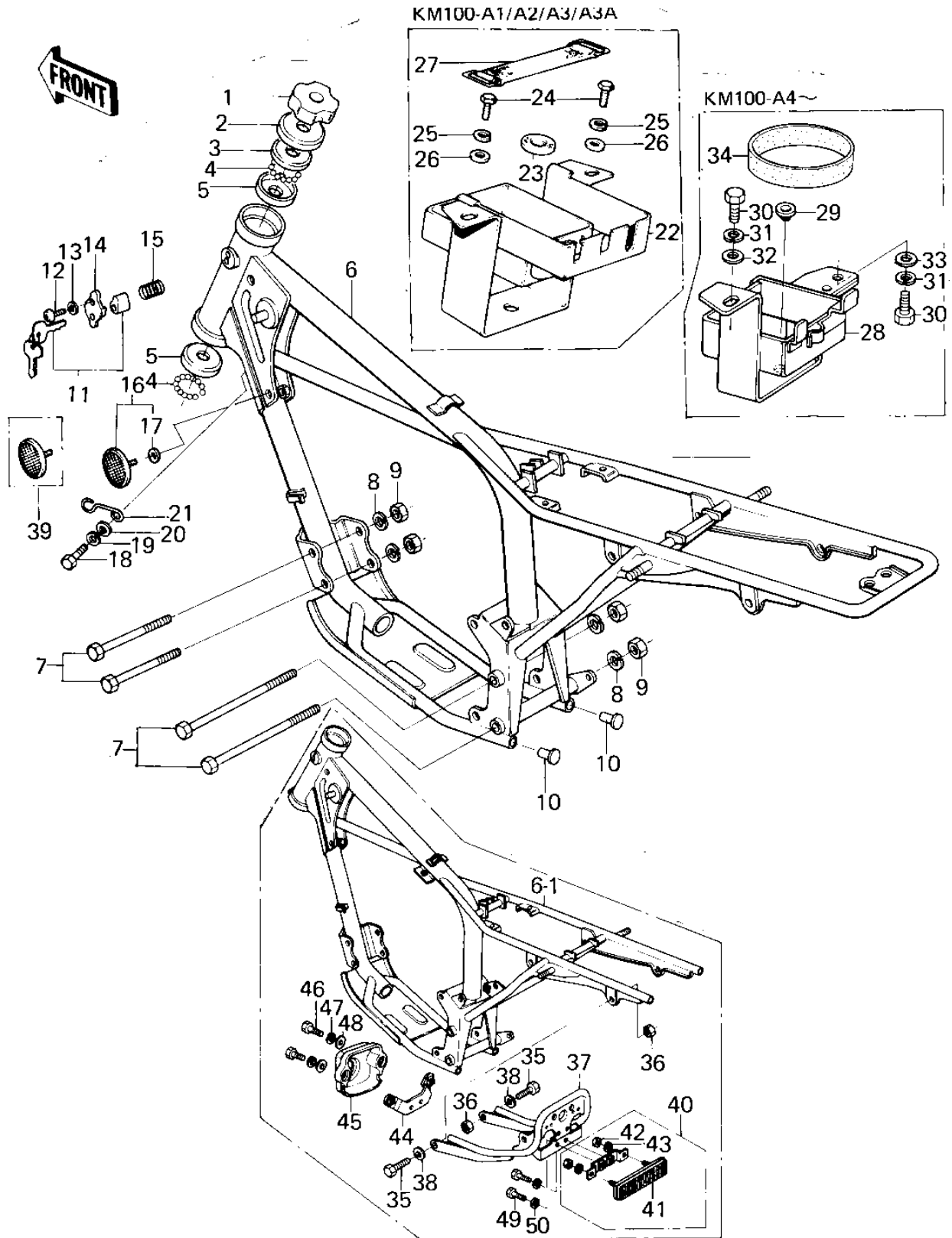

# 1981 KM100 PARTS LIST

## FRAME/FRAME FITTINGS

ITEM NAME	PART NUMBER	QUANTITY
NUT STEERING STEM LCK (Ref # 1)	92090-006	1
CAP STEERING STEM (Ref # 2)	46098-004	1
CONE UPPER BEARING (Ref # 3)	92047-005	1
BALL STEEL 3/16" (Ref # 4)	600A0600	46
RACE BEARING (Ref # 5)	92048-004	2
FRAME (Ref # 6)	32002-109	1
FRAME (Ref # 6)	32002-1043	1
FRAME (Ref # 6-1)	32002-1110	1
UNAVAILABLE IN PRICE BOOK (Ref # 7)	113810115	4
WASHER SPRING 10MM (Ref # 8)	461F1000	4
NUT,10MM (Ref # 9)	314B1000	4
CAP PIPE END (Ref # 10)	32112-001	2
LOCK ASSY,STEERING (Ref # 11)	27016-042	1
SCREW-TAPPING (Ref # 12)	92008-007	1
WASHER (Ref # 13)	92097-003	1
CAP,STEERING LOCK (Ref # 14)	11012-1134	1
CAP,STEERING LOCK (Ref # 14)	11012-1134	1
SPRING-STEERING LOCK (Ref # 15)	27032-001	1
REFLECTOR,REFLEX (Ref # 16)	28001-026	2
DAMPER RUBBER,REFLECT (Ref # 17)	92094-011	2
BOLT-UPSET,6X12 (Ref # 18)	112G0612	1
WASHER SPRING 6MM (Ref # 19)	461F0600	1
WASHER PLAIN 6MM (Ref # 20)	410B0600	1
CLAMP,CABLE (Ref # 21)	92037-117	1
CASE,BATTERY (Ref # 22)	32097-028	1
DAMPER RUBBER (Ref # 23)	92075-078	1
UNAVAILABLE IN PRICE BOOK (Ref # 24)	11080612	2
WASHER SPRING 6MM (Ref # 25)	461F0600	2
WASHER PLAIN 6MM (Ref # 26)	411B0600	2

# 1981 KM100 PARTS LIST

## FRAME/FRAME FITTINGS

ITEM NAME	PART NUMBER	QUANTITY
BAND-CHAIN OILER TANK (Ref # 27)	92072-039	1
CASE,BATTERY (Ref # 28)	32097-1010	1
DAMPER RUBBER (Ref # 29)	92075-078	2
BOLT, HEX HEAD, 6 X 14 (Ref # 30)	110B0614	2
WASHER SPRING 6MM (Ref # 31)	461F0600	2
WASHER PLAIN 6MM (Ref # 32)	411B0600	1
WASHER 6.5X20X1.6T (Ref # 33)	92022-125	1
MAT-BATTERY SIDE (Ref # 34)	32103-023	1
BOLT-SMALL-FINE (Ref # 35)	113B1228	2
NUT-HEX-FINE,12MM (Ref # 36)	315B1200	2
STAY,REAR (Ref # 37)	39137-1006	1
WASHER SPRING 12MM (Ref # 38)	461F1200	2
REFLECTOR,REFLEX (Ref # 39)	28012-016	1
REFLECTOR ASSY,REFLEX (Ref # 40)	28001-1011	1
REFLECTOR,REAR REFLEX (Ref # 41)	28012-1005	1
NUT,5MM (Ref # 42)	311B0500	2
WASHER SPRING 5MM (Ref # 43)	461F0500	2
BRACKET,TAIL LAMP (Ref # 44)	11034-1740	1
COVER,TAIL LAMP (Ref # 45)	14025-1169	1
BOLT-UPSET 6X14 (Ref # 46)	112B0614	2
WASHER SPRING 6MM (Ref # 47)	461F0600	2
WASHER 6.5X20X1.6T (Ref # 48)	92022-125	2
SCREW PAN HEAD 6X12 (Ref # 49)	220B0612	2
WASHER SPRING 6MM (Ref # 50)	461F0600	2