

1979 KM100-A4 PARTS DIAGRAM

FRONT HUB/BRAKE

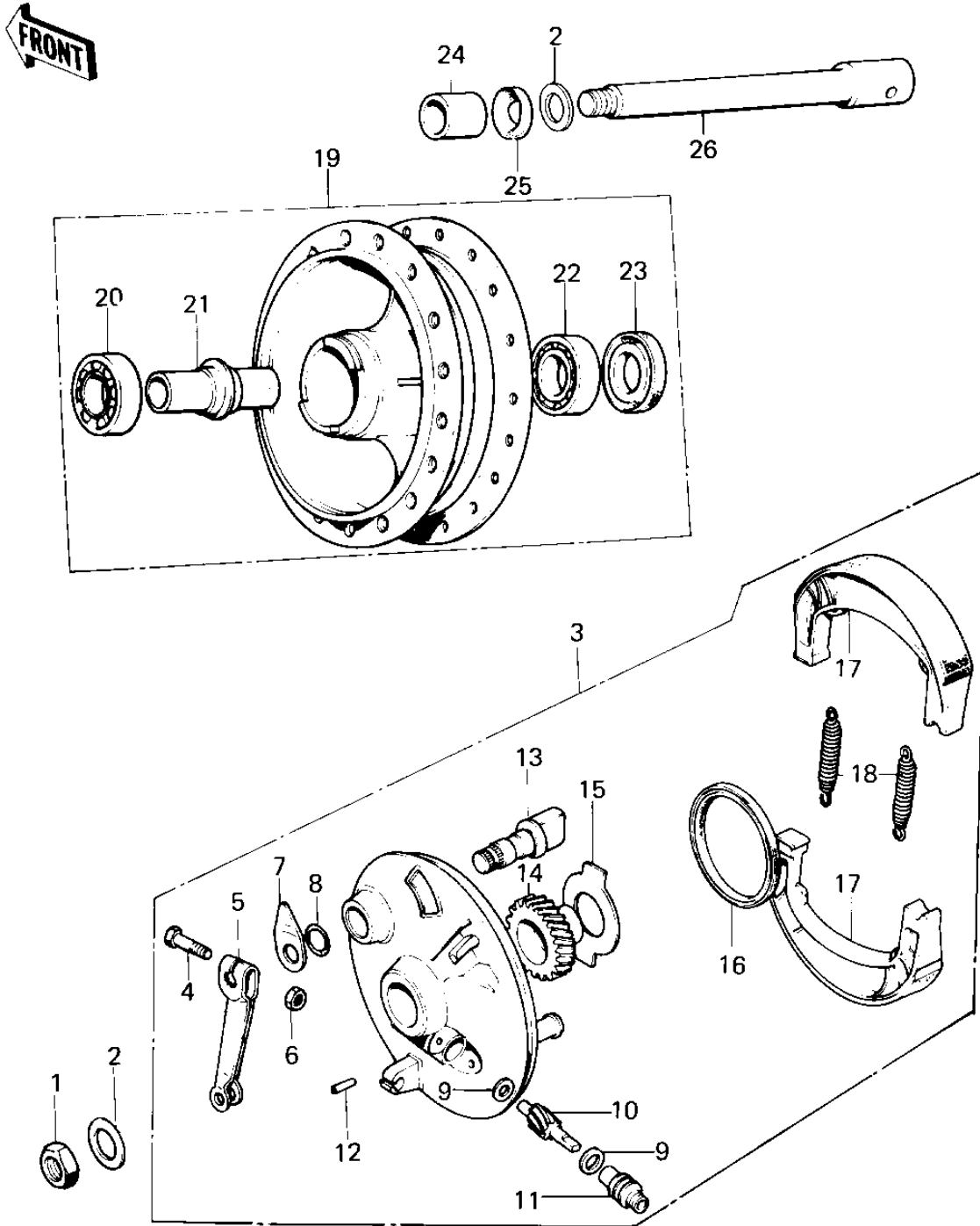

1979 KM100-A4 PARTS LIST

FRONT HUB/BRAKE

ITEM NAME	PART NUMBER	QUANTITY
NUT 10MM (Ref # 1)	42045-005	
WASHER PLAIN 10MM (Ref # 2)	411B1000	
PANEL-ASY,FR BRK (Ref # 3)	41035-1027	
PANEL-ASY,FR BRK (Ref # 3)	41035-1027	
BOLT-UPSET (Ref # 4)	112G0630	
LEVER FRONT BRAKE CAM (Ref # 5)	41053-005	
NUT,6MM (Ref # 6)	41072-007	
INDICATOR,FR BK SHOE (Ref # 7)	41085-013	
"O" RING,11MM (Ref # 8)	92055-004	
WASHER THRST SPD PINI (Ref # 9)	41063-001	
PINION-SPEEDOMETER (Ref # 10)	41060-014	
BUSH,SPEEDMETER CABLE (Ref # 11)	41062-005	
PIN,SPRING (Ref # 12)	41082-001	
CAM SHAFT-FRONT BRAKE (Ref # 13)	41050-018	
GEAR,SPEEDOMETER (Ref # 14)	41060-1026	
GEAR,SPEEDOMETER (Ref # 14)	41060-1026	
RECEIVER,SPEED GEAR (Ref # 15)	41064-010	
OIL SEAL BRAKE PANEL (Ref # 16)	92050-002	
SHOE-BRAKE (Ref # 17)	41048-1085	
SPRING,BRAKE SHOE (Ref # 18)	92081-1766	
DRUM-ASSY,FR BRK (Ref # 19)	41034-1040	
BEARING BALL #6300Z (Ref # 20)	601B6300Z	
SPACER FRONT HUB (Ref # 21)	41039-002	
BEARING BALL #6200 (Ref # 22)	601B6200	
OIL SEAL,TC17317 (Ref # 23)	92050-063	
COLLAR,FRONT AXLE (Ref # 24)	41069-026	
DUST SHIELD FRNT DRUM (Ref # 25)	41042-002	
AXLE-FRONT (Ref # 26)	41068-039	