

1979 KM100-A4 PARTS DIAGRAM

SIDE COVER/OIL TANK (KM100-A1~A4)

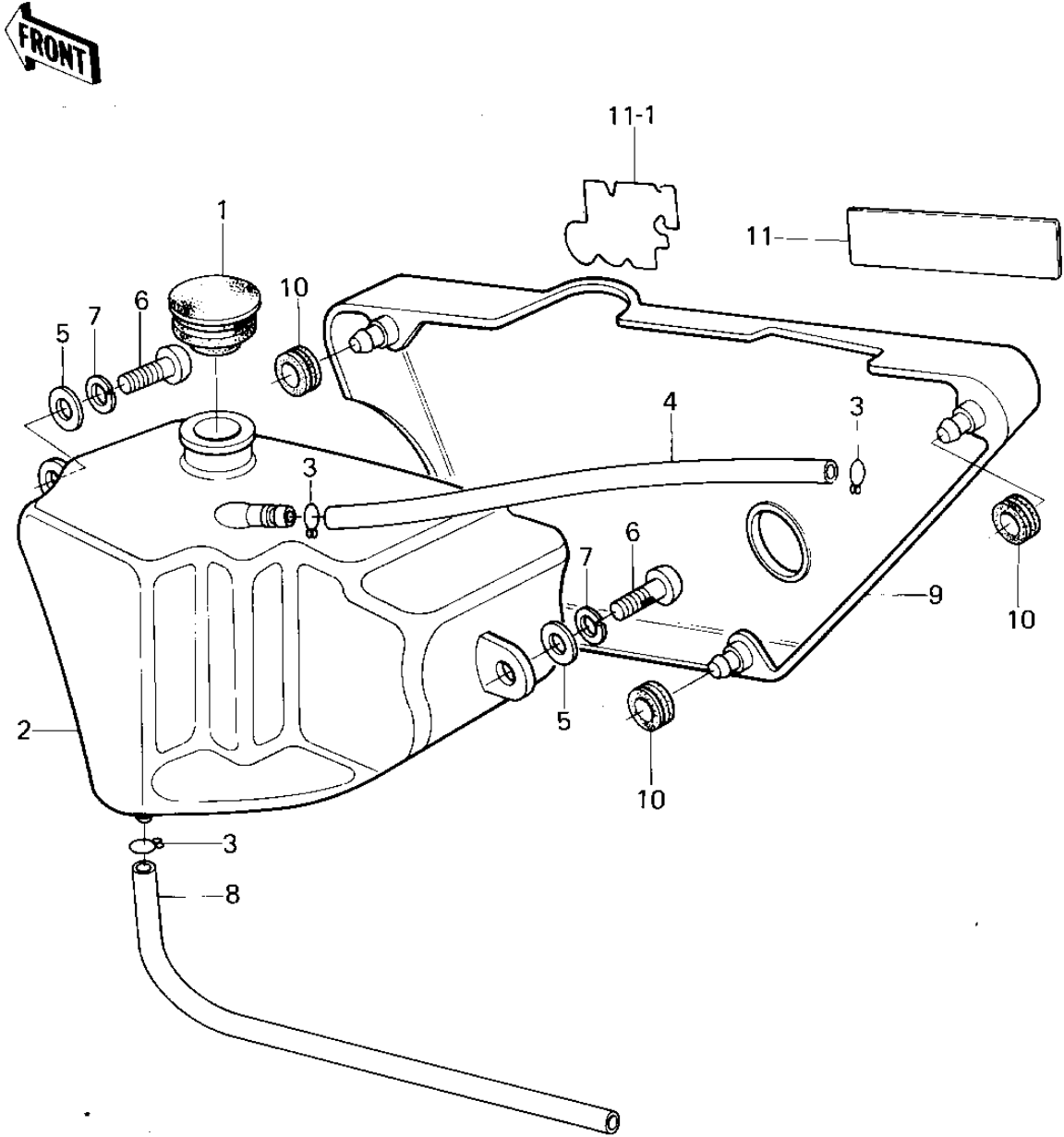

1979 KM100-A4 PARTS LIST

SIDE COVER/OIL TANK (KM100-A1~A4)

ITEM NAME	PART NUMBER	QUANTITY
CAP,OIL TANK (Ref # 1)	52003-024	
TANK,OIL (Ref # 2)	52001-1005	
TANK,OIL (Ref # 2)	52001-1005	
CLAMP FUEL PIPE (Ref # 3)	92037-010	
TUBE-VINYL 5X470 (Ref # 4)	700Q05470	
TUBE-VINYL,5X400 (Ref # 4)	700Q05400	
WASHER 6.5X20X1.6T (Ref # 5)	92022-125	
SCREW PAN HEAD 6X16 (Ref # 6)	220B0616	
WASHER SPRING 6MM (Ref # 7)	461F0600	
TUBE,4.5X9X380 (Ref # 8)	92059-1691	
COVER, SIDE,BLACK (Ref # 9)	36001-1042-6Z	
COVER, SIDE,BLACK (Ref # 9)	36001-1042-6Z	
GROMMET (Ref # 10)	92071-056	
EMBLEM,SIDE COVER (Ref # 11)	56018-241	
EMBLEM,SIDE COVER (Ref # 11-1)	56018-1042	