

1978 KM100-A3 PARTS DIAGRAM

SIDE COVERS/OIL TANK (KM100-A6/A7)

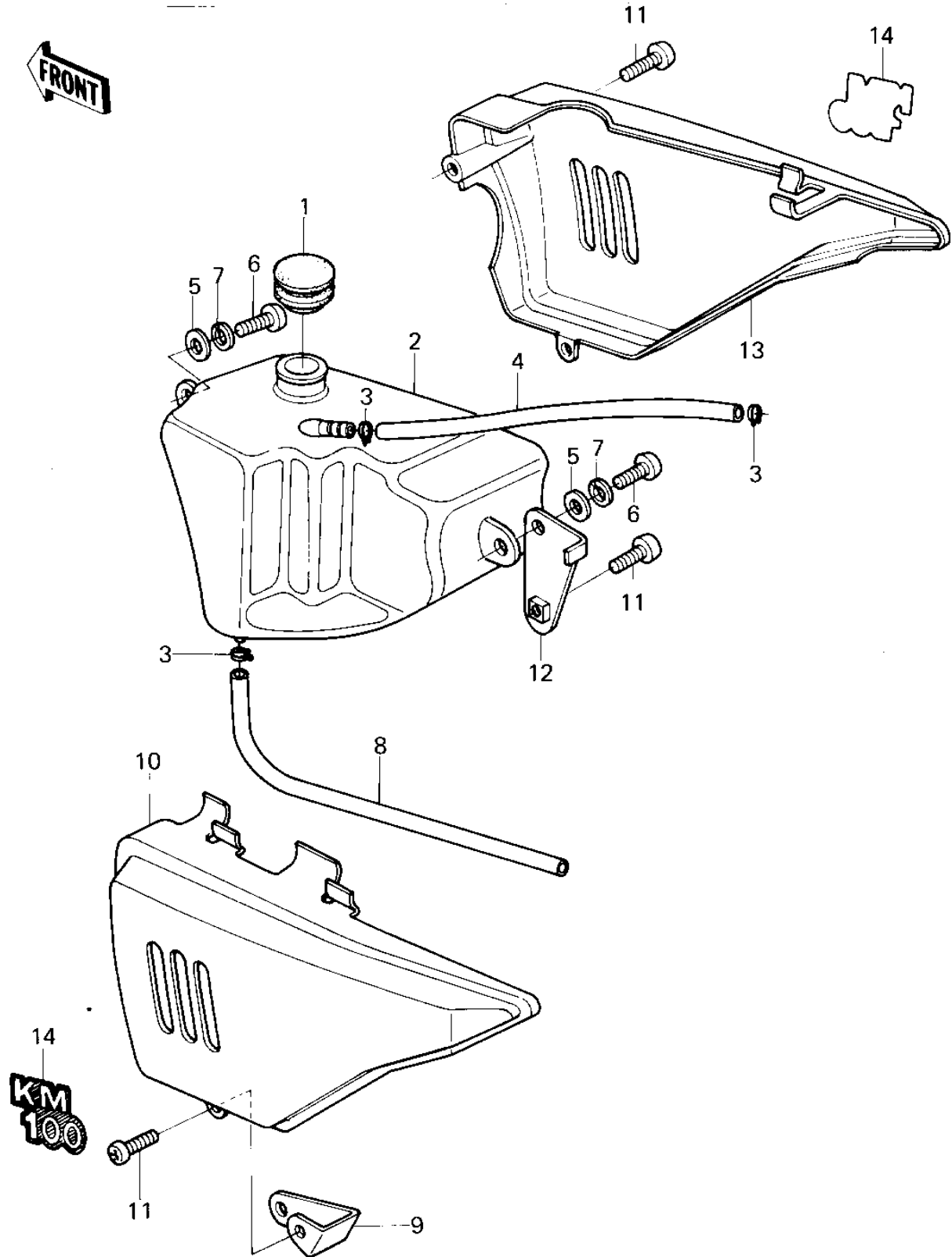

1978 KM100-A3 PARTS LIST

SIDE COVERS/OIL TANK (KM100-A6/A7)

ITEM NAME	PART NUMBER	QUANTITY
CAP,OIL TANK (Ref # 1)	52003-024	
TANK,OIL (Ref # 2)	52001-1005	
CLAMP FUEL PIPE (Ref # 3)	92037-010	
TUBE-VINYL,5X400 (Ref # 4)	700Q05400	
WASHER 6.5X20X1.6T (Ref # 5)	92022-125	
SCREW PAN HEAD 6X16 (Ref # 6)	220B0616	
WASHER SPRING 6MM (Ref # 7)	461F0600	
TUBE,4.5X9X380 (Ref # 8)	92059-1691	
BRACKET,L.H.SIDE COVR (Ref # 9)	11034-1620	
COVER,L.H.SIDE,YELLOW (Ref # 10)	36001-1083-6R	
COVER,L.H.SIDE,F.RED (Ref # 10)	36001-1083-6L	
COVER,L.H.SIDE,F.RED (Ref # 10)	36001-1083-6L	
COVER-SIDE,LH,S.B.YLW (Ref # 10)	36001-1083-6G	
SCREW,6X14 (Ref # 11)	92009-1287	
BRACKET,R.H.SIDE COVR (Ref # 12)	11034-1621	
COVER,R.H.SIDE,YELLOW (Ref # 13)	36001-1084-6R	
COVER,R.H.SIDE,F.RED (Ref # 13)	36001-1084-6L	
COVER,R.H.SIDE,F.RED (Ref # 13)	36001-1084-6L	
COVER-SIDE,RH,S.B.YLW (Ref # 13)	36001-1084-6G	
EMBLEM,SIDE COVER (Ref # 14)	56018-1141	