

# 1979 KD125-A5 PARTS DIAGRAM

## ENGINE COVERS

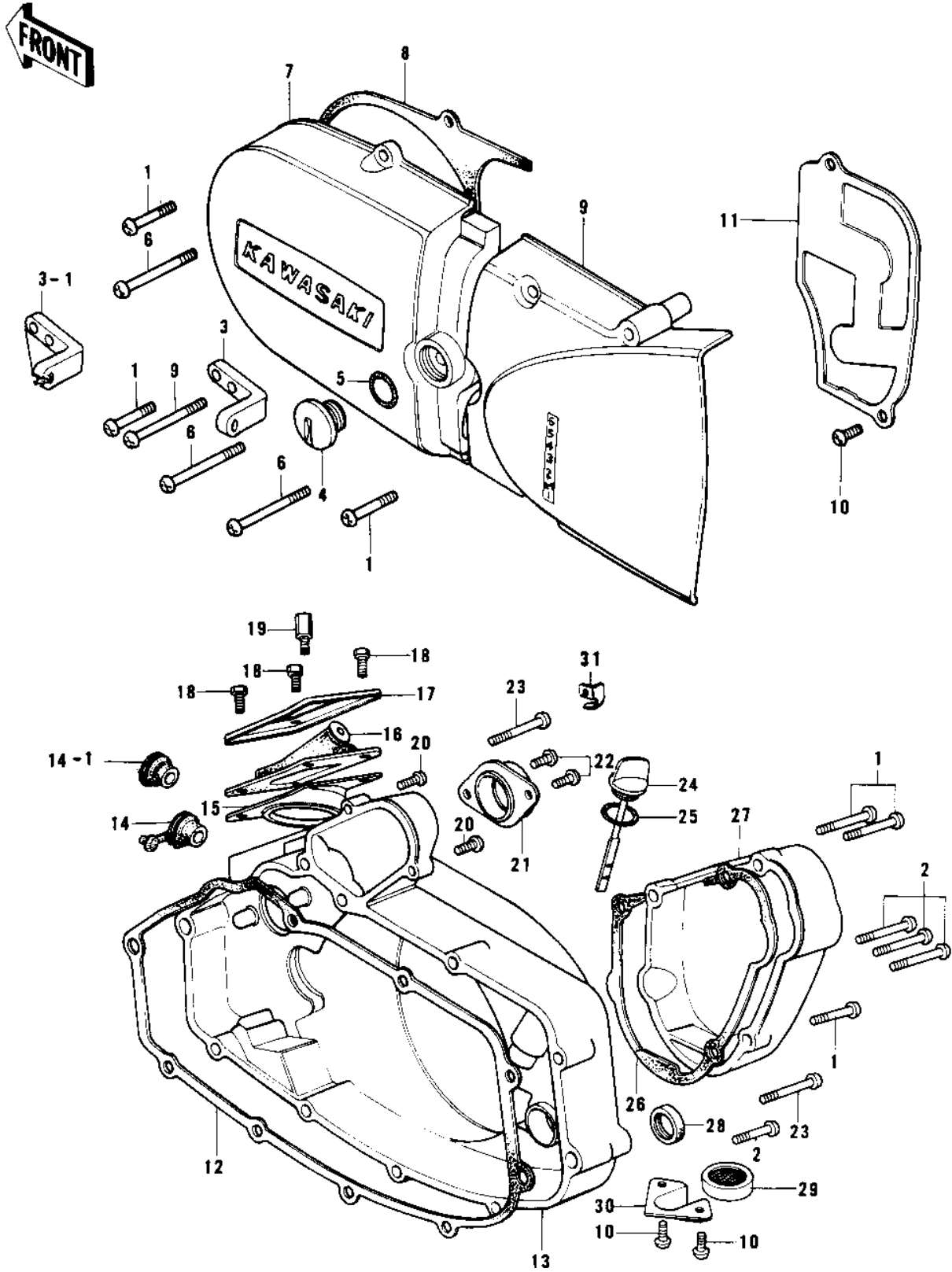

# 1979 KD125-A5 PARTS LIST

## ENGINE COVERS

ITEM NAME	PART NUMBER	QUANTITY
SCREW PAN HEAD 6X20 (Ref # 1)	220B0620	
SCREW PAN HEAD 6X20 (Ref # 1)	220B0620	
SCREW PAN HEAD 6X30 (Ref # 2)	220B0630	
HOLDER,WIRE GUIDE (Ref # 3)	14044-012	
HOLDER,WIRE GUIDE (Ref # 3-1)	14044-012	
PLUG,L.H ENG COVER (Ref # 4)	92067-017	
"O" RING,16MM (Ref # 5)	670B2016	
SCREW PAN HEAD 6X35 (Ref # 6)	220B0635	
COVER,L.H.ENGINE (Ref # 7)	14031-1019-2H	
COVER,L.H.ENGINE (Ref # 7)	14031-1019-2H	
GASKET,L.H ENG COVER (Ref # 8)	14045-017	
COVER,CHN CASE,BARREL (Ref # 9)	14026-020-2H	
COVER,CHAIN CASE (Ref # 9)	14026-1007-2H	
COVER,CHAIN CASE (Ref # 9)	14026-1007-2H	
SCREW PAN HEAD 6X12 (Ref # 10)	220B0612	
COVER,OIL PUMP (Ref # 11)	14030-060	
GASKET,R.H ENG COVER (Ref # 12)	14046-029	
COVER,R.H ENGINE,BUFF (Ref # 13)	14032-123-2H	
COVER,R.H ENG,BARREL (Ref # 13)	14032-120-2H	
COVER,R.H ENG,BARREL (Ref # 13)	14032-120-2H	
COVER,R.H,ENGINE (Ref # 13)	14032-1010-2H	
GROMMET,R.H ENG COV (Ref # 14)	92071-076	
CAP CARB MOUNT HOLE (Ref # 14-1)	14039-001	
CAP,CARBURETOR (Ref # 15)	14038-039	
CAP,CARBURETOR (Ref # 16)	14038-042	
HOLDER,CARBRETOR CAP (Ref # 17)	14065-007	
BOLT-UPSET (Ref # 18)	112G0618	
BOLT,CARBURETOR CAP (Ref # 19)	92001-130	
UNAVAILABLE IN PRICE BOOK (Ref # 20)	214B0516A	

# 1979 KD125-A5 PARTS LIST

## ENGINE COVERS

ITEM NAME	PART NUMBER	QUANTITY
UNAVAILABLE IN PRICE BOOK (Ref # 20)	214B0516A	
HOLDER,CARBURETOR (Ref # 21)	16065-033	
SCREW PAN HEAD 6X12 (Ref # 22)	220B0612	
SCREW PAN HEAD 6X45 (Ref # 23)	220B0645	
PLUG,OIL FILLER (Ref # 24)	16115-020	
"O" RING,20MM (Ref # 25)	670B2020	
GASKET,CARB COVER (Ref # 26)	14048-005	
GASKET,CARBURETOR COV (Ref # 26)	11009-1277	
COVER,CARB.BARREL (Ref # 27)	14030-1006-2H	
COVER,CARBURETOR,BARL (Ref # 27)	14030-071-2H	
COVER,CARBURETOR,BARL (Ref # 27)	14030-071-2H	
OIL SEAL SB16244 (Ref # 28)	92049-002	
DRAIN,FUEL (Ref # 29)	16116-006	
COVER,FUEL DRAIN (Ref # 30)	14076-006	
GUIDE,CABLE (Ref # 31)	54030-012	