

1976 KE125 PARTS DIAGRAM

SPECIAL SERVICE TOOLS ('76-'79)

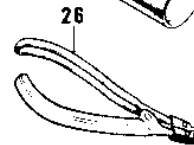
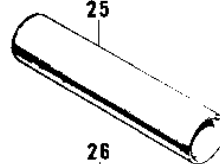
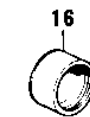
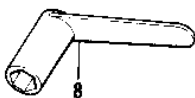
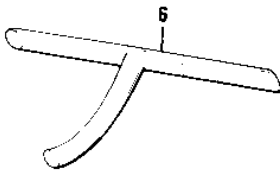
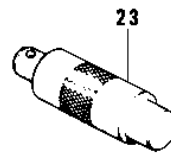
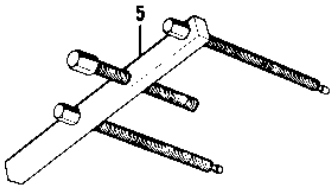
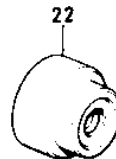
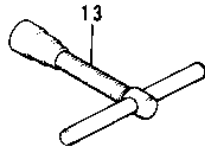
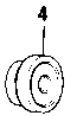
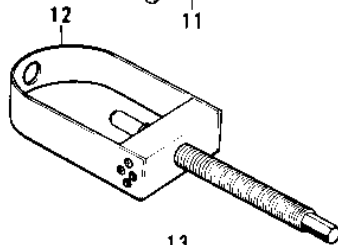
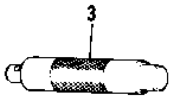
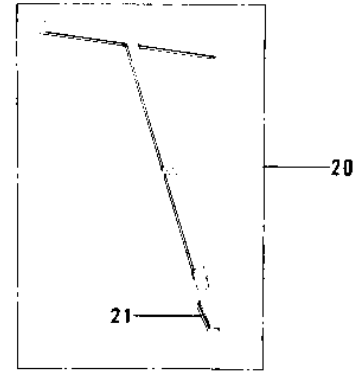
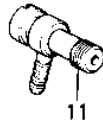
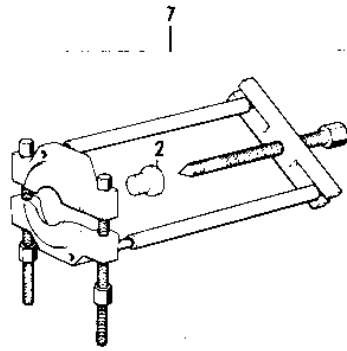
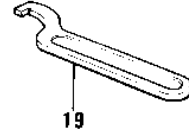
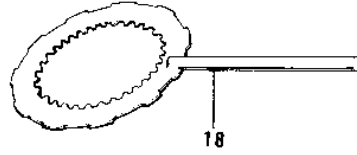
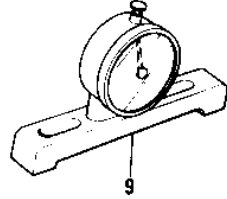
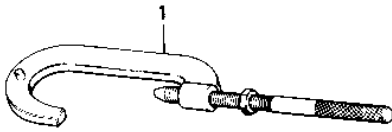

1976 KE125 PARTS LIST

SPECIAL SERVICE TOOLS ('76-'79)

ITEM NAME	PART NUMBER	QUANTITY
57001-1243 (Canada) (Ref # 1)	56019-040	1
*** N.L.A.*** (Canada) (Ref # 2)	57001-166	1
*** N.L.A.*** (Canada) (Ref # 3)	57001-139	1
57001-1129 (Canada) (Ref # 4)	57001-140	1
57001-1098 (Canada) (Ref # 5)	57001-153	1
57001-1243 (Canada) (Ref # 6)	57001-155	1
PULLER,STEM BEARING (Ref # 7)	57001-158	1
ADJUSTER,CLTCH RELEASE (Ref # 8)	57001-159	1
FINDER-TDC (Ref # 9)	57001-160	1
*** N.L.A.*** (Canada) (Ref # 10)	57001-195	1
*** N.L.A.*** (Canada) (Ref # 11)	57001-206	1
57001-910 (Canada) (Ref # 12)	57001-233	1
PULLER,FLYWHEL MAGNET (Ref # 13)	57001-252	1
GUIDE,OIL SEAL (Ref # 14)	57001-263	1
57001-1129 (Canada) (Ref # 15)	57001-284	1
DRIVER,STEM BEARING (Ref # 16)	57001-292	1
*** N.L.A.*** (Canada) (Ref # 17)	57001-293	1
57001-1243 (Canada) (Ref # 18)	57001-303	1
57001-1100 (Canada) (Ref # 19)	57001-320	1
57001-1011 (Canada) (Ref # 20)	57001-179	1
57001-1011 (Canada) (Ref # 21)	57001-181	1
57001-1129 (Canada) (Ref # 22)	57001-282	1
57001-1129 (Canada) (Ref # 23)	57001-286	1
*** N.L.A.*** (Canada) (Ref # 24)	57001-130	1
DRIVER,STEM BEARING (Ref # 25)	57001-137	1
PLIERS-PISTON RING (Ref # 26)	57001-115	1