

# 1975 KX125-A PARTS DIAGRAM

## SPECIAL SERVICE TOOLS

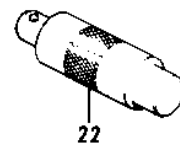
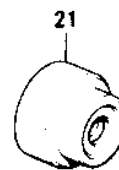
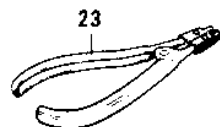
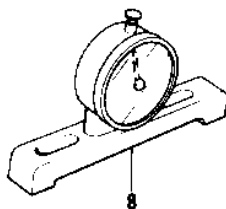
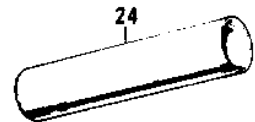
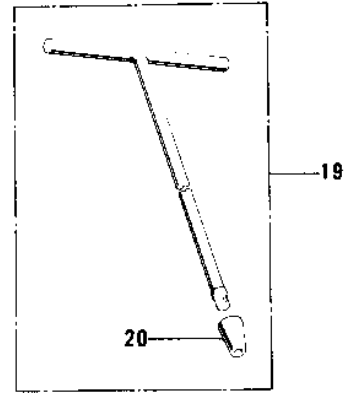
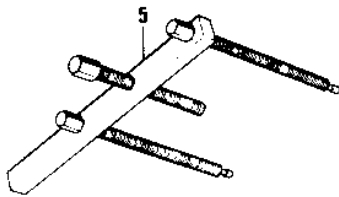
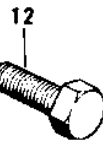
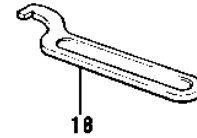
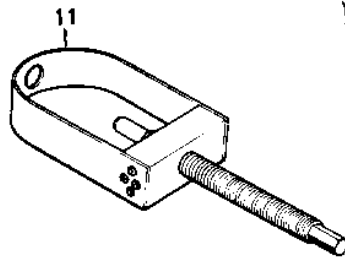
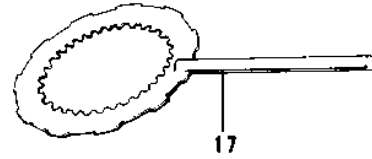
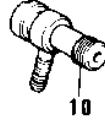
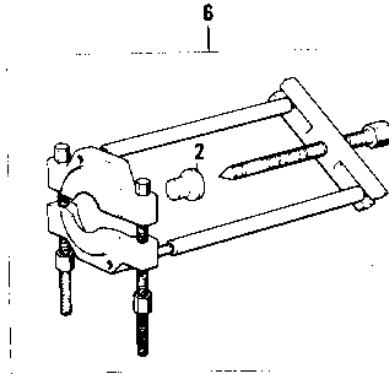
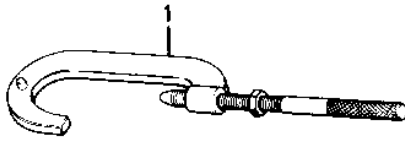

# 1975 KX125-A PARTS LIST

## SPECIAL SERVICE TOOLS

ITEM NAME	PART NUMBER	QUANTITY
57001-1243 (Canada) (Ref # 1)	56019-040	
ADAPTER,STEM BEARING (Ref # 2)	57001-136	
*** N.L.A.*** (Canada) (Ref # 3)	57001-139	
57001-1129 (Canada) (Ref # 4)	57001-140	
57001-1098 (Canada) (Ref # 5)	57001-153	
PULLER,STEM BEARING (Ref # 6)	57001-158	
ADJUSTER,CLTCH RELEASE (Ref # 7)	57001-159	
FINDER-TDC (Ref # 8)	57001-160	
*** N.L.A.*** (Canada) (Ref # 9)	57001-195	
GAUGE,FUEL LEVEL (Ref # 10)	57001-207	
57001-910 (Canada) (Ref # 11)	57001-233	
57001-1216 (Canada) (Ref # 12)	57001-251	
GUIDE,OIL SEAL (Ref # 13)	57001-263	
57001-1129 (Canada) (Ref # 14)	57001-284	
DRIVER,STEM BEARING (Ref # 15)	57001-292	
*** N.L.A.*** (Canada) (Ref # 16)	57001-293	
57001-1243 (Canada) (Ref # 17)	57001-303	
57001-1100 (Canada) (Ref # 18)	57001-320	
57001-1011 (Canada) (Ref # 19)	57001-179	
UNAVAILABLE IN PRICE BOOK (Ref # 20)	57001-180	
57001-1129 (Canada) (Ref # 21)	57001-282	
57001-1129 (Canada) (Ref # 22)	57001-286	
PLIERS-PISTON RING (Ref # 23)	57001-115	
DRIVER,STEM BEARING (Ref # 24)	57001-137	
*** N.L.A.*** (Canada) (Ref # 25)	57001-130	