

1978 KD175-A3 PARTS DIAGRAM

CRANKCASE

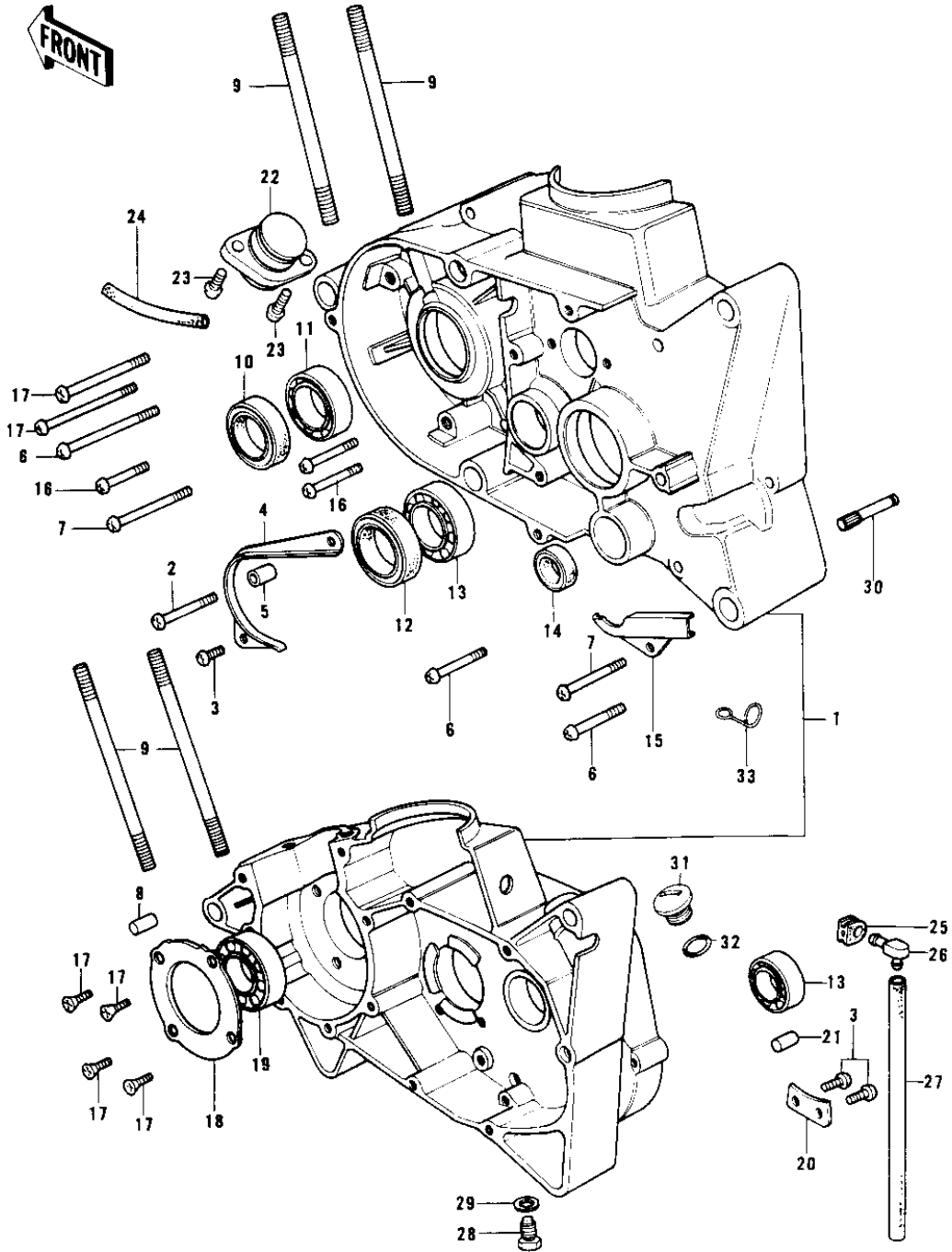

1978 KD175-A3 PARTS LIST

CRANKCASE

ITEM NAME	PART NUMBER	QUANTITY
CRANKCASE SET (Ref # 1)	14001-074-21	
SCREW PAN HEAD 6X85 (Ref # 2)	220B0685	
SCREW PAN HEAD 6X12 (Ref # 3)	220B0612	
GUIDE-CHAIN (Ref # 4)	14077-002	
COLLAR (Ref # 5)	92027-169	
SCREW PAN HEAD 6X55 (Ref # 6)	220B0655	
SCREW PAN HEAD 6X65 (Ref # 7)	220B0665	
PIN,DOWEL,10X8.2X14 (Ref # 8)	92043-1037	
STUD 8X75 (Ref # 9)	172G0875	
SEAL-OIL (Ref # 10)	92049-1250	
BEARING BALL #6205 (Ref # 11)	601B6205	
OIL SEAL SC30426 (Ref # 12)	92050-039	
BEARING-BALL,6204C3 (Ref # 13)	92045-1046	
OIL SEAL SB12205 (Ref # 14)	92049-004	
COVER-WIRING HARNESS (Ref # 15)	14076-002	
SCREW PAN HEAD 6X40 (Ref # 16)	220B0640	
SCREW CNTSNK HD 6X16 (Ref # 17)	221B0616	
HOLDER-CRANK BEARING (Ref # 18)	14014-021	
BEARING BALL #6305 (Ref # 19)	601B6305	
HOLDER-MISSION BERNG (Ref # 20)	14014-022	
PIN DOWEL 8X16 (Ref # 21)	551A0816	
PUMP-FUEL DRAIN (Ref # 22)	16137-002	
SCREW PAN HEAD 6X16 (Ref # 23)	220B0616	
PIPE FUEL OVERFLOW (Ref # 24)	92059-031	
GROMMET (Ref # 25)	92071-042	
BREATHER ASSY (Ref # 26)	14069-1001	
PIPE-BREATHER (Ref # 27)	92059-061	
PLUG OIL DRAIN (Ref # 28)	92067-001	
GASKET CHECK VALVE (Ref # 29)	92065-058	

1978 KD175-A3 PARTS LIST

CRANKCASE

ITEM NAME	PART NUMBER	QUANTITY
PIN,KICK SPRING (Ref # 30)	92043-117	
PLUG,L.H ENG COVER (Ref # 31)	92067-017	
GASKET,L.H ENG COV PL (Canada) (Ref # 32)	92065-064	
CLAMP (Ref # 33)	92037-053	