

1978 KD175-A3 PARTS DIAGRAM

SIDE COVER/OIL TANK/CHAIN COVER

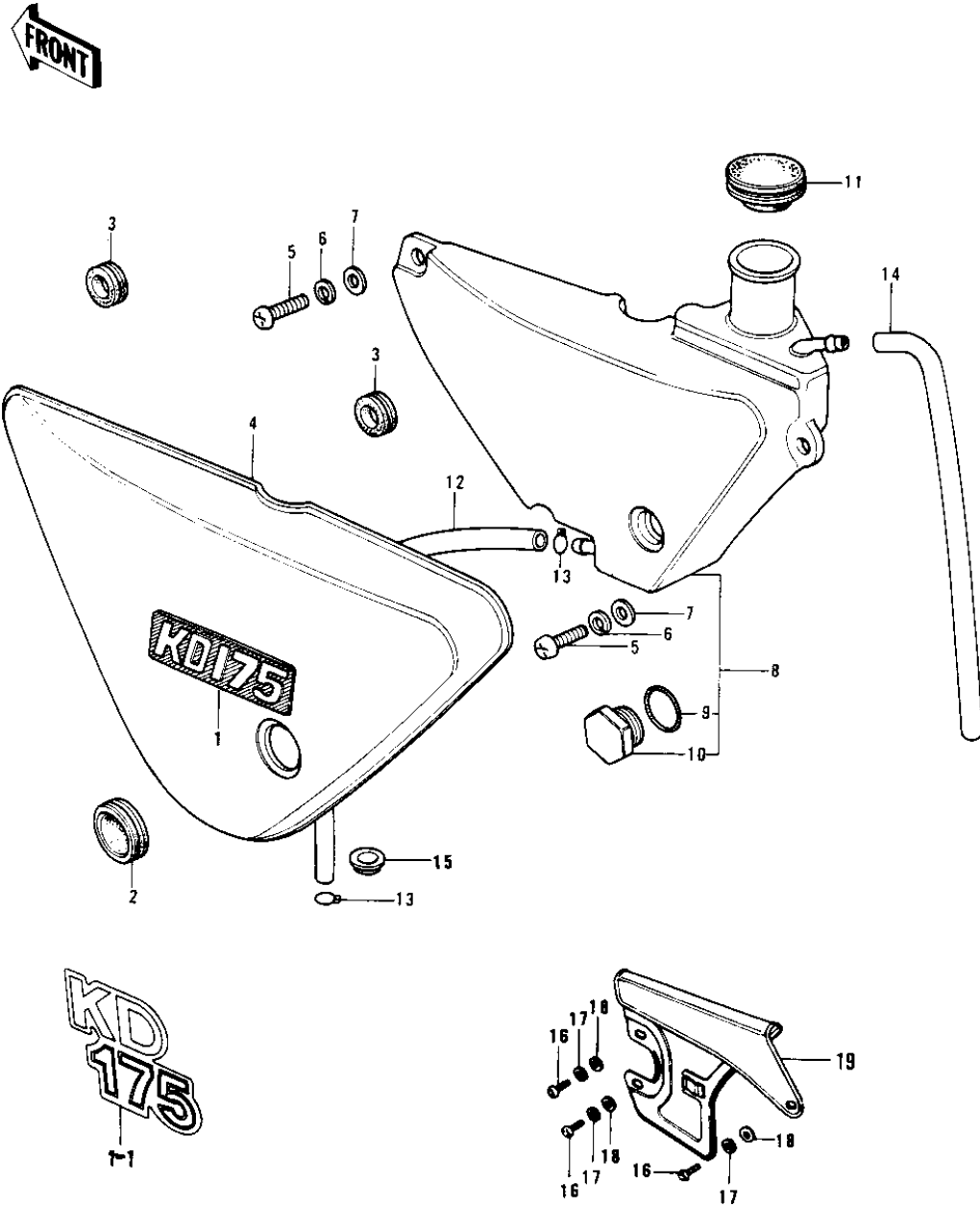

1978 KD175-A3 PARTS LIST

SIDE COVER/OIL TANK/CHAIN COVER

ITEM NAME	PART NUMBER	QUANTITY
EMBLEM,SIDE COVER (Ref # 1)	56018-220	
MARK,SIDE COVER (Ref # 1-1)	56018-1095	
GROMMET,L.H SIDE COV (Ref # 2)	92071-080	
GROMMET (Ref # 3)	92071-056	
COVER,L.H SIDE,F.BLK (Ref # 4)	36001-049-21	
COVER,L.H,SIDE BLACK (Ref # 4)	36001-1051-21	
SCREW PAN HEAD 6X14 (Ref # 5)	220B0614	
WASHER SPRING 6MM (Ref # 6)	461F0600	
WASHER 6.5X20X1.6T (Ref # 7)	92022-125	
TANK, OIL (Ref # 8)	52001-041	
"O" RING,20MM (Ref # 9)	92055-051	
GUAGE-OIL LEVEL (Ref # 10)	52015-002	
CAP-OIL TANK (Ref # 11)	51049-1004	
PIPE (Ref # 12)	92059-064	
CLAMP FUEL PIPE (Ref # 13)	92037-010	
TUBE-VINYL,5X600 (Ref # 14)	700Q05600	
TUBE,VINYL,5X310 (Ref # 14)	700Q05310	
GROMMET PIPE (Ref # 15)	92071-038	
SCREW PAN HEAD 6X14 (Ref # 16)	220B0614	
WASHER SPRING 6MM (Ref # 17)	461F0600	
WASHER PLAIN (Ref # 18)	92022-024	
CASE-CHAIN,FR BLACK (Ref # 19)	36014-051-21	