

1982 KDX175 PARTS DIAGRAM

TRANSMISSION ('81-'82 A2/A3)

E1361-0031

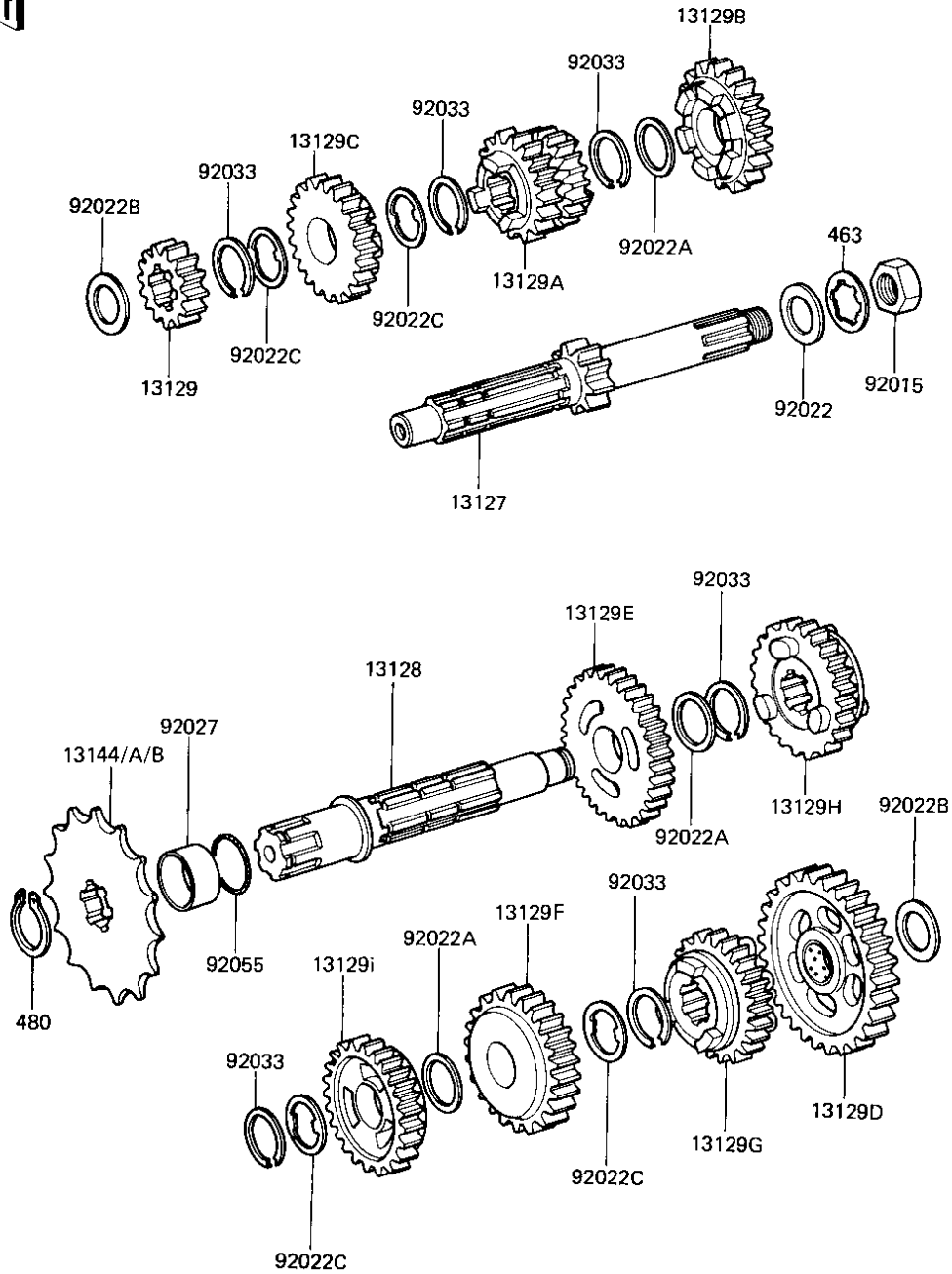

1982 KDX175 PARTS LIST

TRANSMISSION ('81-'82 A2/A3)

ITEM NAME	PART NUMBER	QUANTITY
SHAFT,DRIVE (Ref # 13127)	13127-1026	1
SHAFT,OUTPUT (Ref # 13128)	13128-1026	1
2ND GEAR,DRIVE SHAFT (Ref # 13129)	13129-1181	1
3RD&4TH GEAR,DRIVE S (Ref # 13129A)	13129-1182	1
5TH GEAR,DRIVE SHAFT (Ref # 13129B)	13129-1183	1
TOP GEAR,DRIVE SHAFT (Ref # 13129C)	13129-1184	1
LOW GEAR,OUTPUT SHAF (Ref # 13129D)	13129-1185	1
2ND GEAR,OUTPUT SHAF (Ref # 13129E)	13129-1186	1
3RD GEAR,OUTPUT SHAF (Ref # 13129F)	13129-1187	1
5TH GEAR,OUTPUT SHAF (Ref # 13129G)	13129-1189	1
TOP GEAR,OUTPUT SHAF (Ref # 13129H)	13129-1190	1
GEAR-TRANSMISSION SP (Ref # 13129I)	13129-1324	1
ENGINE SPROCKET,11T (Ref # 13144)	13144-1036	1
SPROCKET-OUTPUT,12T (Ref # 13144A)	13144-1049	1
SPROCKET-OUTPUT 13T (Ref # 13144B)	13144-1050	1
NUT 16MM (Ref # 92015)	92016-036	1
WASHER,16.8X32X1.6 (Ref # 92022)	92022-1277	1
WASHER-PLAIN (Ref # 92022A)	92022-198	3
WASHER,PLAIN (Ref # 92022B)	92022-268	2
WASHER-LOCK (Ref # 92022C)	92024-039	4
COLLAR,ENGINE SPROCK (Ref # 92027)	92027-1244	1
CIRCLIP,25MM (Ref # 92033)	92033-025	6
"O" RING (Ref # 92055)	92055-022	1
WASHER,TOOTHED,16M/M (Ref # 463)	463H1600	1
CIRCLIP, 20MM (Ref # 480)	480J2000	1