

1982 KDX175 PARTS DIAGRAM

HEADLIGHT ('81-'82 A2/A3)

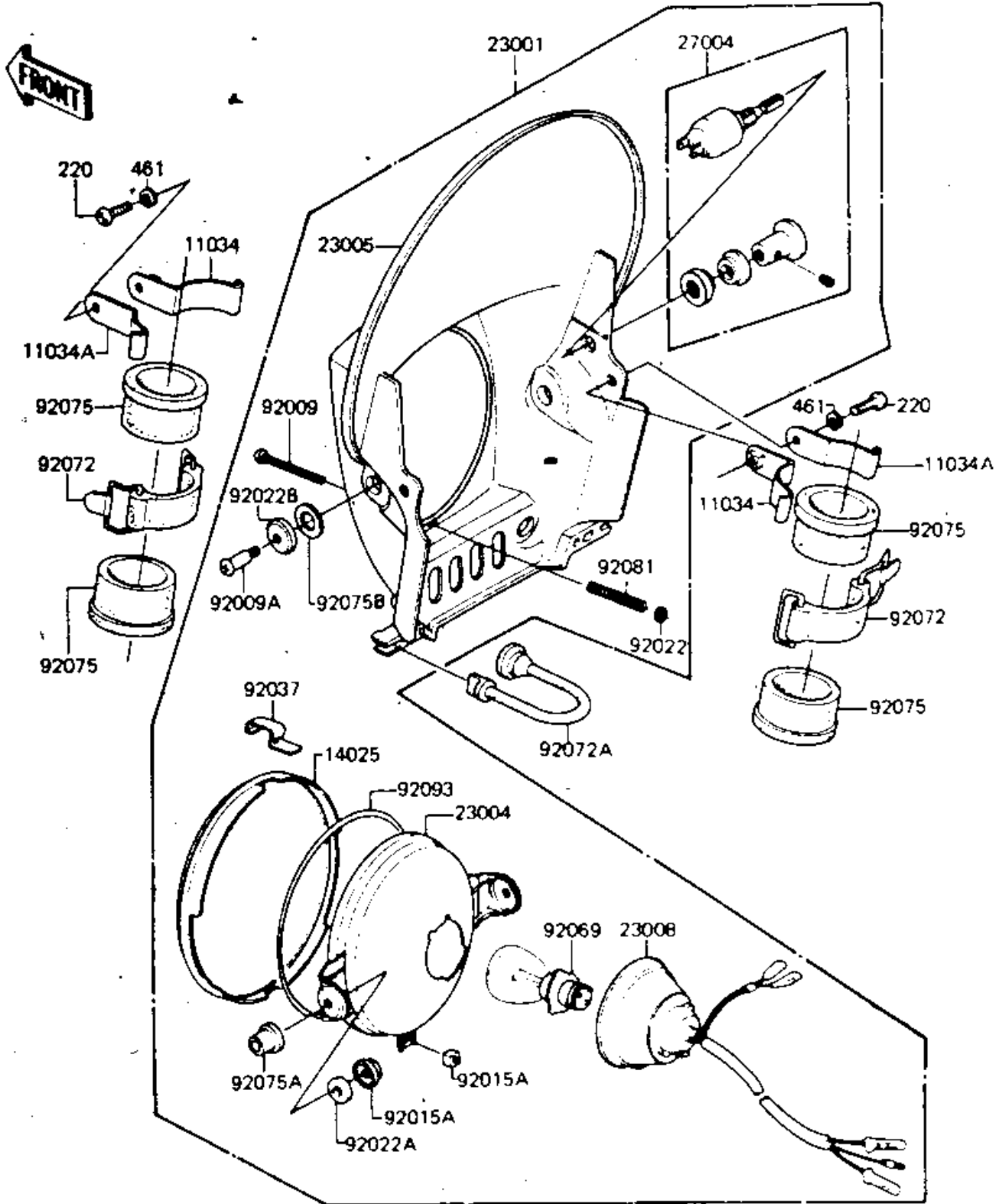

1982 KDX175 PARTS LIST

HEADLIGHT ('81-'82 A2/A3)

ITEM NAME	PART NUMBER	QUANTITY
BRACKET,HEAD LMP PFI (Ref # 11034)	11034-1688	2
BRACKET,HEAD LMP FIT (Ref # 11034A)	11034-1693	2
COVER,HEAD LAMP (Ref # 14025)	14025-4002	1
HEAD LAMP ASSY (Ref # 23001)	23001-4001	1
LAMP,HEAD (Ref # 23004)	23004-4001	1
BODY-COMP-HEAD LAMP, (Ref # 23005)	23005-5002-7F	1
SOCKET,HEAD LAMP (Ref # 23008)	23008-4001	1
SWITCH,HEAD LAMP (Ref # 27004)	27004-4001	1
SCREW,ADJUSTING,4X43 (Ref # 92009)	92009-4002	1
SCREW,HEAD LAMP (Ref # 92009A)	92009-4003	2
NUT,4MM (Ref # 92015)	23020-018	1
NUT,HEAD LAMP RIM FI (Ref # 92015A)	23020-023	1
WASHER (Ref # 92022)	23021-004	1
WASHER-PLAIN,5MM (Ref # 92022A)	23021-012	2
WASHER,HEAD LAMP (Ref # 92022B)	92022-4005	2
CLAMP,HEAD LAMP (Ref # 92037)	92037-4001	3
BULB,6V 35/25W (Ref # 92069)	92069-4001	1
BAND,FUEL TANK (Ref # 92072)	92072-076	2
BAND,HEAD LAMP (Ref # 92072A)	92072-077	2
DAMPER,HEAD LMP FITT (Ref # 92075)	92075-1236	4
DAMPER,HEAD LAMP (Ref # 92075A)	92075-4009	2
DAMPER,HEAD LAMP (Ref # 92075B)	92075-4010	2
SPRING,FOCUS ADJUSTN (Ref # 92081)	92081-4003	1
SEAL,HEAD LAMP (Ref # 92093)	92093-4001	1
SCREW PAN HEAD 6X16 (Ref # 220)	220B0616	2
WASHER SPRING 6MM (Ref # 461)	461F0600	2