

1977 KE175 PARTS DIAGRAM

FRONT HUB/BRAKE

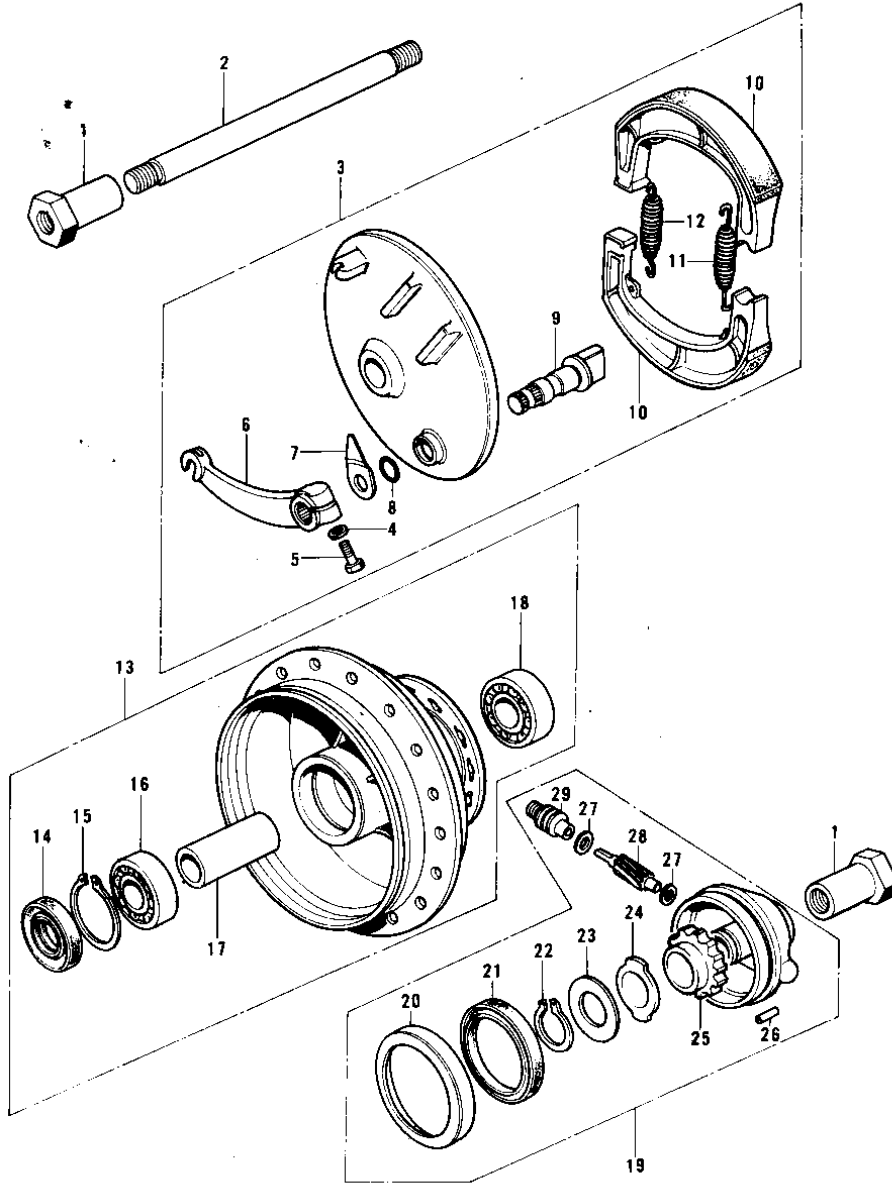

1977 KE175 PARTS LIST

FRONT HUB/BRAKE

ITEM NAME	PART NUMBER	QUANTITY
COLLAR,FRONT AXLE (Ref # 1)	41069-024	
AXLE,FRONT (Ref # 2)	41068-043	
PANEL-ASY,FR BRK BUFF (Ref # 3)	41035-076-80	
WASHER PLAIN 6MM (Ref # 4)	410B0600	
BOLT 6X22 (Ref # 5)	112B0622	
LEVER,FRNT BRAKE CAM (Ref # 6)	41053-020	
INDICATOR,FR BRK PNL (Ref # 7)	41085-002	
CAM SHAFT,FRONT BRAKE (Ref # 8)	41050-012	
CAM SHAFT,FRONT BRAKE (Ref # 9)	41050-012	
SHOE,BRAKE (Ref # 10)	41048-015	
SPRING,BRAKE SHOE (Ref # 11)	92081-1766	
SPRING,BRAKE SHOE (Ref # 12)	92081-1550	
DRUM-ASSY,FR BRK,BUFF (Ref # 13)	41034-031-80	
OIL SEAL,FR BK DRUM (Ref # 14)	92050-059	
CIRCLIP.37MM (Ref # 15)	481J3700	
BEARING BALL #6301 (Ref # 16)	601B6301	
SPACER,FR HUB BEARING (Ref # 17)	41039-025	
BEARING BALL #6201 (Ref # 18)	601B6201	
CASE ASSY,SPEED GEAR (Ref # 19)	41078-009	
DUST COVER (Ref # 20)	41042-013	
OIL SEAL (Ref # 21)	654A405208	
CIRCLIP,19MM (Ref # 22)	480J1900	
WASHER,THRUST (Ref # 23)	41065-004	
RECEIVER,SPEED GEAR (Ref # 24)	41064-011	
GEAR,SPEEDOMETER (Ref # 25)	41059-024	
PIN,SPRING (Ref # 26)	41082-001	
WASHER THRST SPD PINI (Ref # 27)	41063-001	
PINION,SPEEDOMETER (Ref # 28)	41060-015	
BUSH,SPEEDMETER CABLE (Ref # 29)	41062-005	