

1978 KE175 PARTS DIAGRAM

TURN SIGNALS

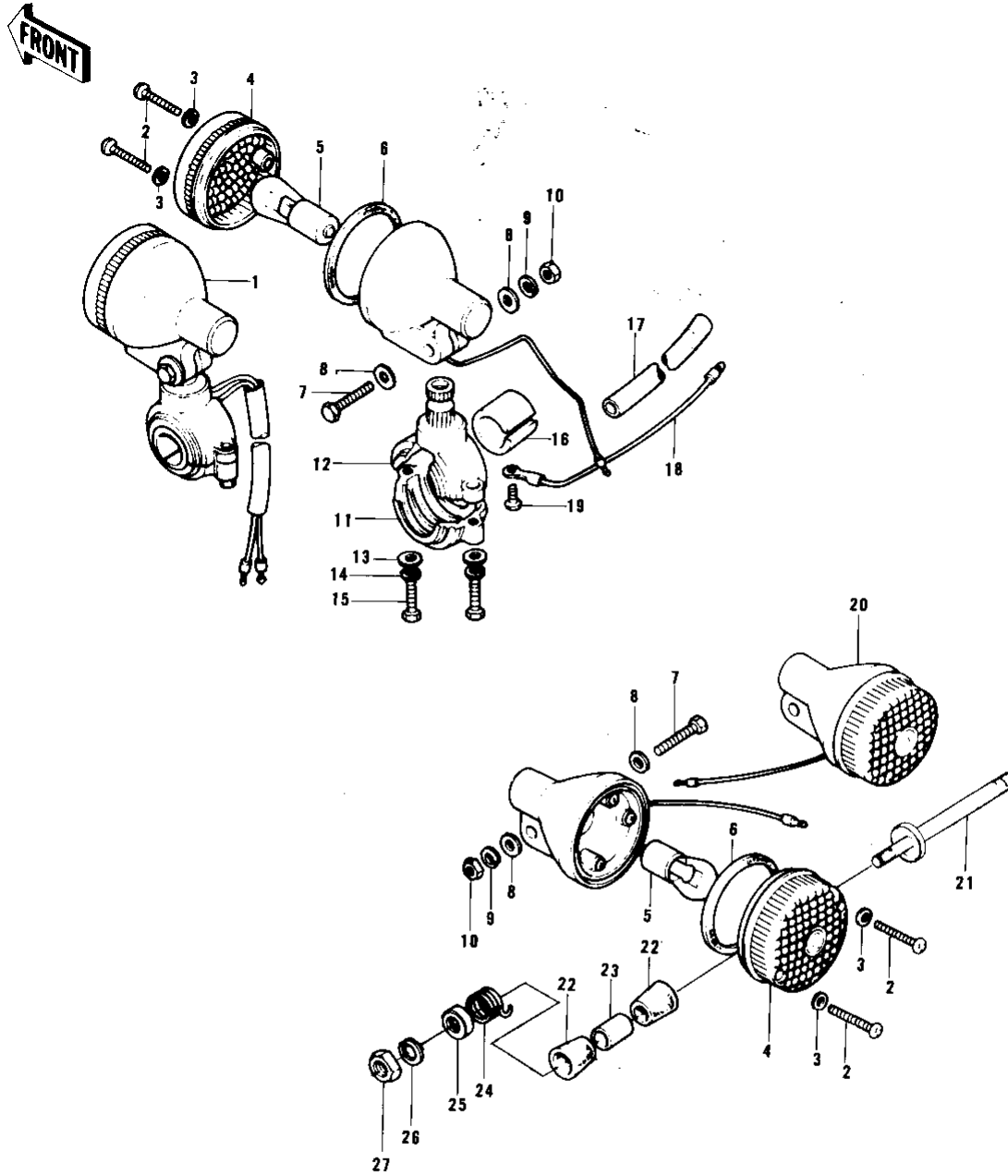

1978 KE175 PARTS LIST

TURN SIGNALS

ITEM NAME	PART NUMBER	QUANTITY
LAMP ASY-FR TURN SIG (Ref # 1)	23037-005	
SCREW-PAN HEAD,4X20 (Ref # 2)	220E0420A	
WASHER-PLAIN,4MM (Ref # 3)	23058-002	
LENS,TURN SIGNAL LAMP (Ref # 4)	23048-1001	
BULB,6V 21CP (Ref # 5)	92069-056	
GASKET-SIG LAMP LENS (Ref # 6)	23050-003	
BOLT-UPSET (Ref # 7)	112G0630	
WASHER-PLAIN,6MM (Ref # 8)	411D0600	
WASHER SPRING 6MM (Ref # 9)	461F0600	
NUT 6MM (Ref # 10)	311B0600	
BRACKET,FRNT TURN SIG (Ref # 11)	23051-1004	
BRACKET,SIGNAL LAMP (Ref # 12)	23051-1013	
WASHER-PLAIN,5MM (Ref # 13)	410D0500	
WASHER SPRING 5MM (Ref # 14)	461F0500	
BOLT (Ref # 15)	110N0516	
DAMPER RUBBER (Ref # 16)	23066-003	
COVER-WIRING HARNESS (Ref # 17)	26009-004	
WIRE-TURN SIGNAL LEAD (Ref # 18)	26011-061	
SCREW PAN HEAD 3X5 (Ref # 19)	220B0305A	
LAMP-REAR TURN SIGNAL (Ref # 20)	23040-033	
BKT,RR SIGNAL LAMP (Ref # 21)	23051-048	
DAMPER RUBBER (Ref # 22)	92075-148	
COLLAR 12.7X17.3X30 (Ref # 23)	92027-168	
SPRING (Ref # 24)	92081-111	
WASHER CUP 12.5X35X4T (Ref # 25)	92022-235	
WASHER SPRING 12MM (Ref # 26)	461F1200	
NUT-HEX-FINE,12MM (Ref # 27)	315B1200	