

1982 KLT200 PARTS DIAGRAM

TRANSMISSION ('81-'82 KLT200-A1/A2/A3)

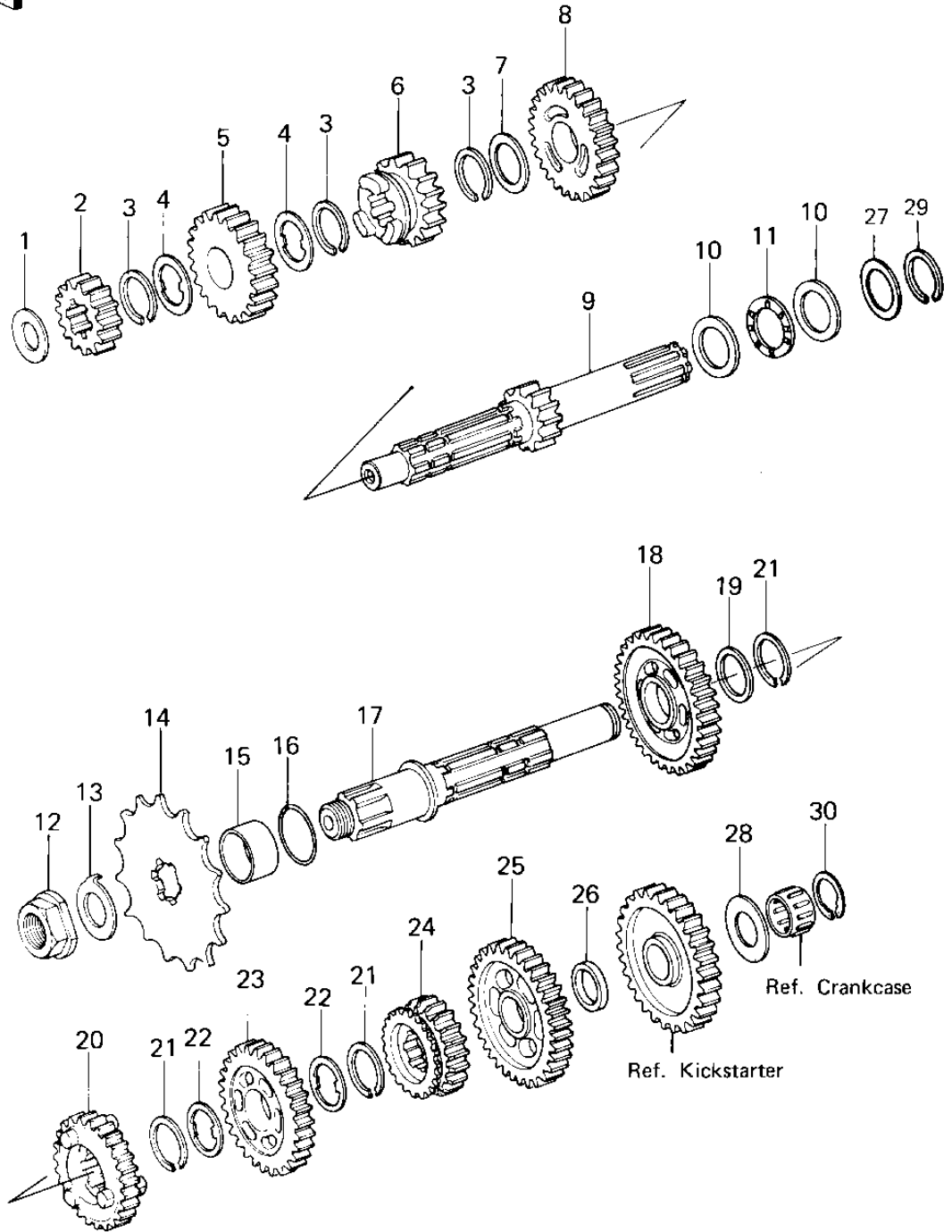

1982 KLT200 PARTS LIST

TRANSMISSION ('81-'82 KLT200-A1/A2/A3)

ITEM NAME	PART NUMBER	QUANTITY
WASHER,THRUST,15MM (Ref # 1)	92022-279	1
2ND GEAR,DRIVE SHAFT (Ref # 2)	13129-1022	1
CIRCLIP,25MM (Ref # 3)	92033-025	3
WASHER-LOCK (Ref # 4)	92024-039	2
4TH GEAR,DRIVE SHAFT (Ref # 5)	13134-026	1
GEAR,INPUT,3RD,20T (Ref # 6)	13129-1284	1
WASHER-PLAIN (Ref # 7)	92022-198	1
TOP GEAR,DRIVE SHAFT (Ref # 8)	13136-057	1
SHAFT,DRIVE (Ref # 9)	13127-053	1
WASHER,PLAIN (Ref # 10)	92022-314	2
BRG,NEEDLE,AXK1104 (Ref # 11)	92046-052	1
NUT,LOCK,16M/M (Ref # 12)	92015-1013	1
WASHER,LOCK (Ref # 13)	92022-1017	1
SPROCKET-OUTPUT,13T (Ref # 14)	13144-1038	1
SPROCKET-OUTPUT,12T (Ref # 14)	13144-1039	(1
COLLAR,ENGINE SPROCKT (Ref # 15)	92027-287	1
"O" RING (Ref # 16)	92055-022	1
SHAFT,OUTPUT (Ref # 17)	13128-1007	1
2ND GEAR,OUTPUT 26T (Ref # 18)	13131-044	1
WASHER-PLAIN (Ref # 19)	92022-198	1
GEAR,OUTPUT 4TH,21T (Ref # 20)	13129-1285	1
CIRCLIP,25MM (Ref # 21)	92033-025	3
WASHER-LOCK (Ref # 22)	92024-039	2
3RD GEAR,OUTPUT SHAFT (Ref # 23)	13133-044	1
TOP GEAR,OUTPUT SHAFT (Ref # 24)	13137-037	1
LOW GEAR,OUTPUT SHAFT (Ref # 25)	13129-058	1
SPACER (Ref # 26)	92026-114	1
WASHER THRUST (Ref # 27)	92022-112	1
WASHER,PLAIN (Ref # 28)	92022-270	1