

1981 KLT200 PARTS DIAGRAM

FUEL TANK ('81-'82 KLT200-A1/A2/A3)

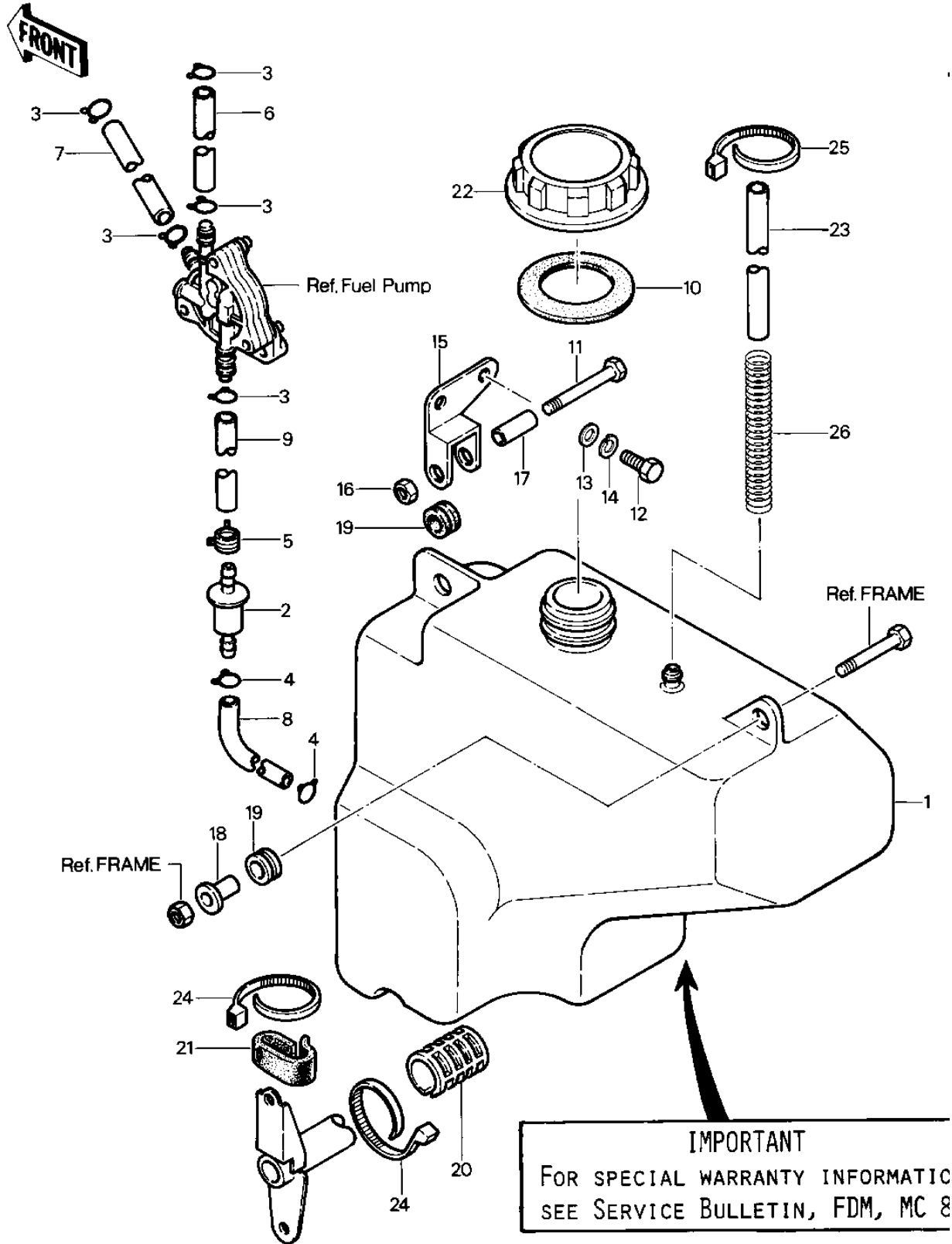

1981 KLT200 PARTS LIST

FUEL TANK ('81-'82 KLT200-A1/A2/A3)

ITEM NAME	PART NUMBER	QUANTITY
TANK-FUEL,GRAY (Ref # 1)	51001-4003-8L	1
TANK-FUEL,GRAY (Ref # 1)	51001-4003-8L	1
FILTER-FUEL (Ref # 2)	49019-3502	1
CLAMP,CARB CONECT HOS (Ref # 3)	92037-056	5
CLAMP-FUEL TUBE (Ref # 4)	92037-3501	2
CLAMP (Ref # 5)	92037-4009	1
TUBE,6.5X11.5X350 (Ref # 6)	92059-4004	1
TUBE,6.5X11.5X290 (Ref # 7)	92059-4028	1
TUBE,FUEL (Ref # 8)	92059-4011	1
TUBE,6.5X11.5X85 (Ref # 9)	92059-4014	1
GASKET,FUEL TANK CAP (Ref # 10)	11009-3020	1
BOLT-SMALL-UPSET,8X30 (Ref # 11)	115G0830	1
BOLT-UPSET,6X12 (Ref # 12)	112G0612	2
WASHER PLAIN 6MM (Ref # 13)	411B0600	2
WASHER SPRING 6MM (Ref # 14)	461F0600	2
BRKT,TANK (Ref # 15)	32052-4005	1
NUT,LOCK,8MM (Ref # 16)	92015-1124	1
SPACER FUEL TANK MONT (Ref # 17)	92027-012	1
COLLAR,FUEL TANK FITT (Ref # 18)	92027-1134	1
DAMPER RUBB TANK FRNT (Ref # 19)	92075-013	2
DAMPER RUBBER (Ref # 20)	92075-084	2
DAMPER (Ref # 21)	92075-4024	1
CAP,FUEL TANK (Ref # 22)	51049-3001	1
TUBE (Ref # 23)	92059-4009	1
BAND (Ref # 24)	92072-3505	3
BAND (Ref # 25)	92072-4004	3
SPRING (Ref # 26)	92081-4011	1