

1975 Mach I PARTS DIAGRAM

TURN SIGNALS

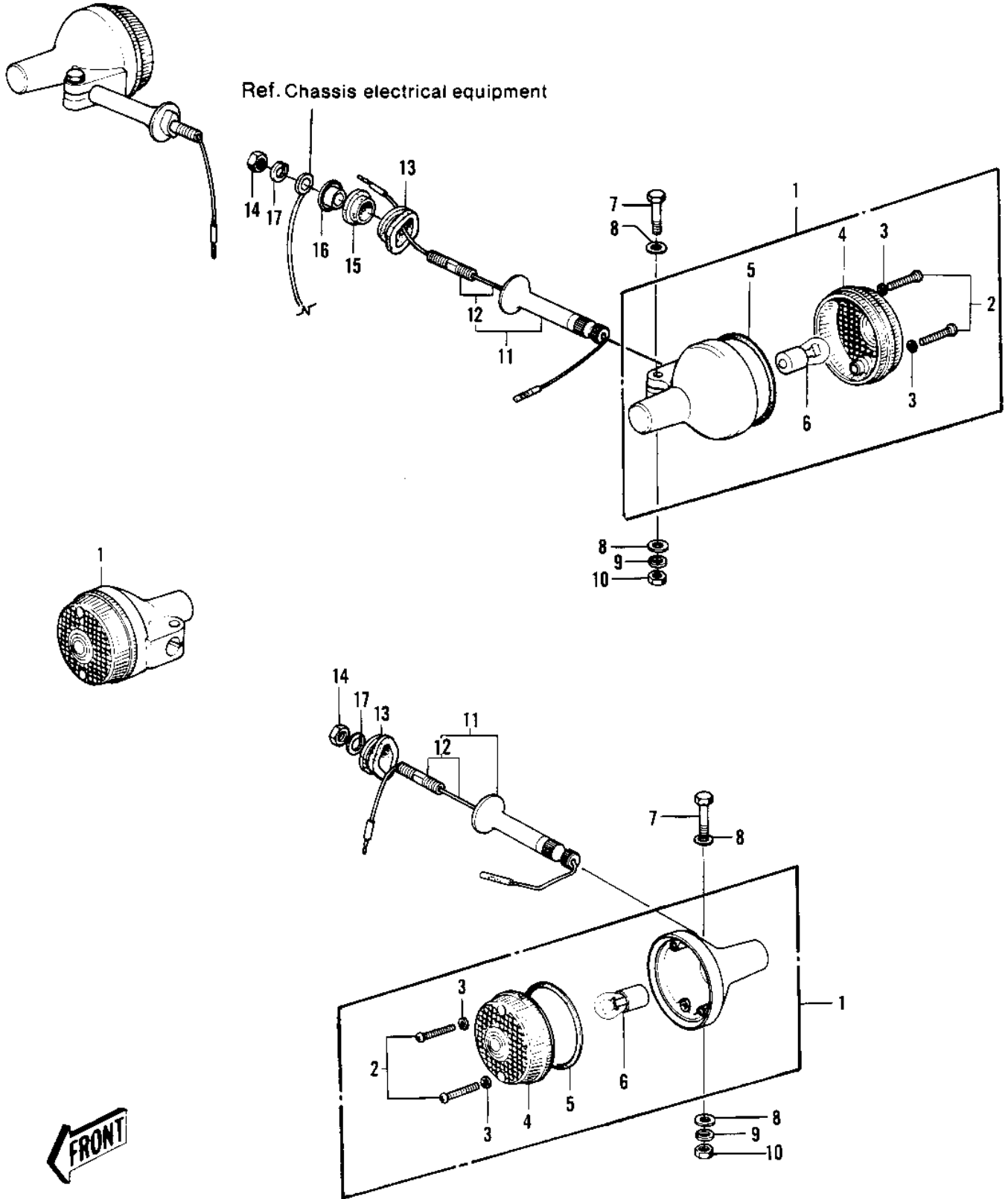

1975 Mach I PARTS LIST

TURN SIGNALS

ITEM NAME	PART NUMBER	QUANTITY
LAMP ASSY-TURN SIGNAL (Ref # 1)	23040-037	
SCREW-PAN HEAD,4X20 (Ref # 2)	220E0420A	
WASHER-PLAIN,4MM (Ref # 3)	23058-002	
LENS,TURN SIGNAL LAMP (Ref # 4)	23048-1001	
GASKET-SIG LAMP LENS (Ref # 5)	23050-003	
BULB 12V 32CP (Ref # 6)	92069-055	
BOLT-UPSET (Ref # 7)	112G0630	
WASHER PLAIN 6MM (Ref # 8)	410B0600	
WASHER PLAIN 6MM (Ref # 8)	411B0600	
WASHER SPRING 6MM (Ref # 9)	461F0600	
NUT 6MM (Ref # 10)	311B0600	
BRACKET-TURN SIG LAMP (Ref # 11)	23078-001	
BOLT SET-SIG LAMP BKT (Ref # 12)	23073-001	
DAMPER RUBBER (Ref # 13)	92075-128	
NUT 10MM (Ref # 14)	315B1000	
DAMPER RUBBER,SIG LM (Ref # 15)	92075-158	
COLLAR (Ref # 16)	92027-147	
WASHER SPRING 10MM (Ref # 17)	461F1000	