

# 1979 KLR250 PARTS DIAGRAM

MUFFLER (78-'79 KL250-A1/A1A/A2)

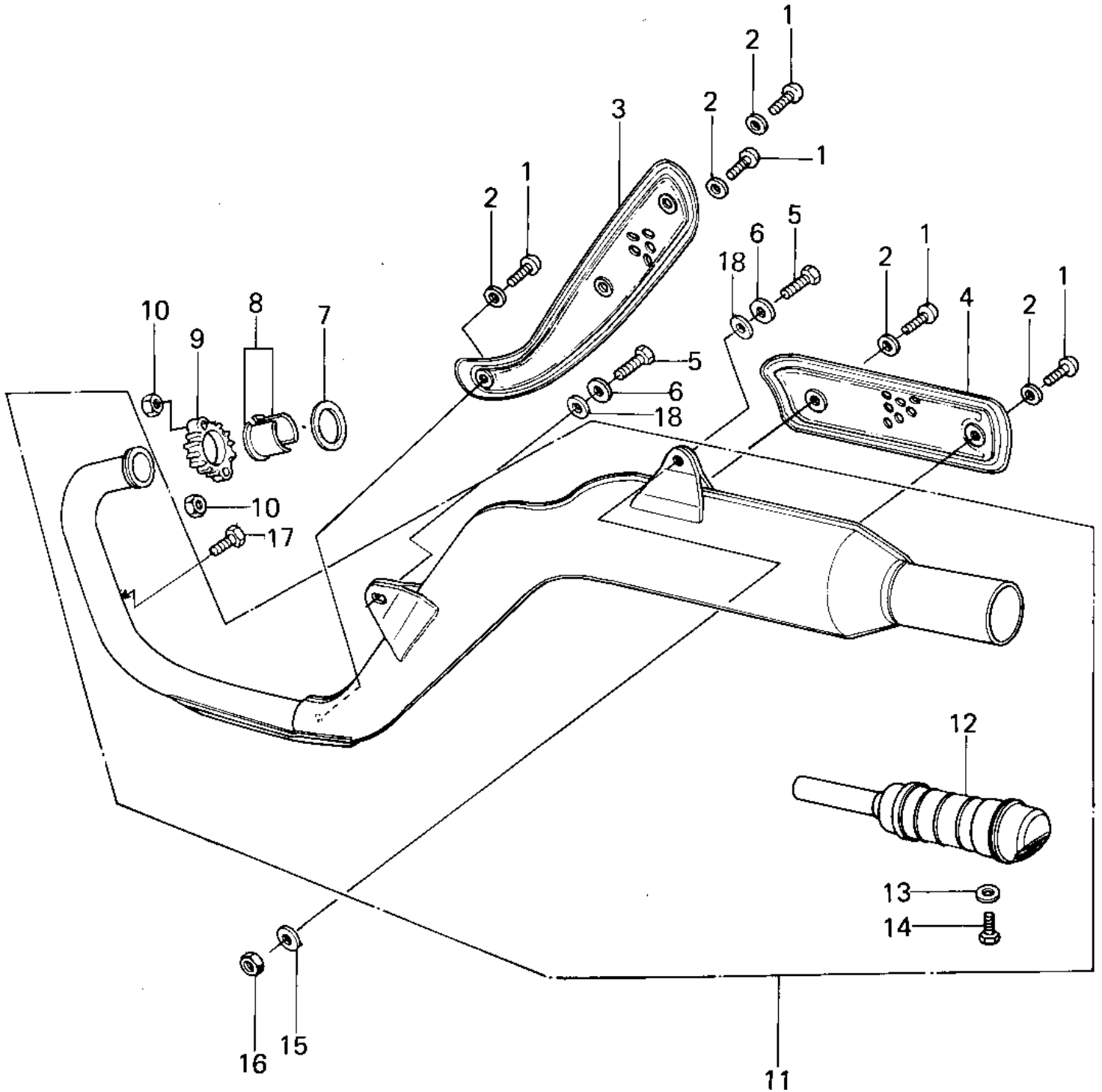

# 1979 KLR250 PARTS LIST

MUFFLER ('78-'79 KL250-A1/A1A/A2)

ITEM NAME	PART NUMBER	QUANTITY
SCREW-PAN-CROS,6X10,B (Ref # 1)	220C0610	5
WASHER LOCK 6MM (Ref # 2)	464H0600	5
COVER,MUFFLER,FRONT (Ref # 3)	14025-1003-21	1
COVER,MUFFLER,REAR (Ref # 4)	14025-1004-21	1
BOLT,8X20 (Ref # 5)	115G0820	2
WASHER PLAIN 8MM (Ref # 6)	411B0800	2
GASKET,EXHAUST PIPE H (Ref # 7)	11009-1866	1
INSERT,EXHAUST PIPE (Ref # 8)	92027-278	2
HOLDER,EXHAUST PIPE (Ref # 9)	18069-1006	1
NUT,LOCK 6MM (Ref # 10)	92017-014	2
MUFFLER ASSY (Ref # 11)	18001-5018	1
MUFFLER ASSY (Ref # 11)	18001-5018	1
BAFFLE PIPE,MUFFLER (Ref # 12)	49099-1002	1
WASHER PLAIN 6MM (Ref # 13)	410B0600	1
BOLT-UPSET,6X12 (Ref # 14)	112G0612	1
WASHER PLAIN 8MM (Ref # 15)	410B0800	1
NUT 8MM (Ref # 16)	311G0800	1
BOLT (6X10) (Ref # 17)	110R0610	1
WASHER,8.5X20X1.6 (Ref # 18)	92022-1561	2