

1992 650 SX PARTS DIAGRAM

Handle Pole(KAW64651 91&NAMI.)

F3171A

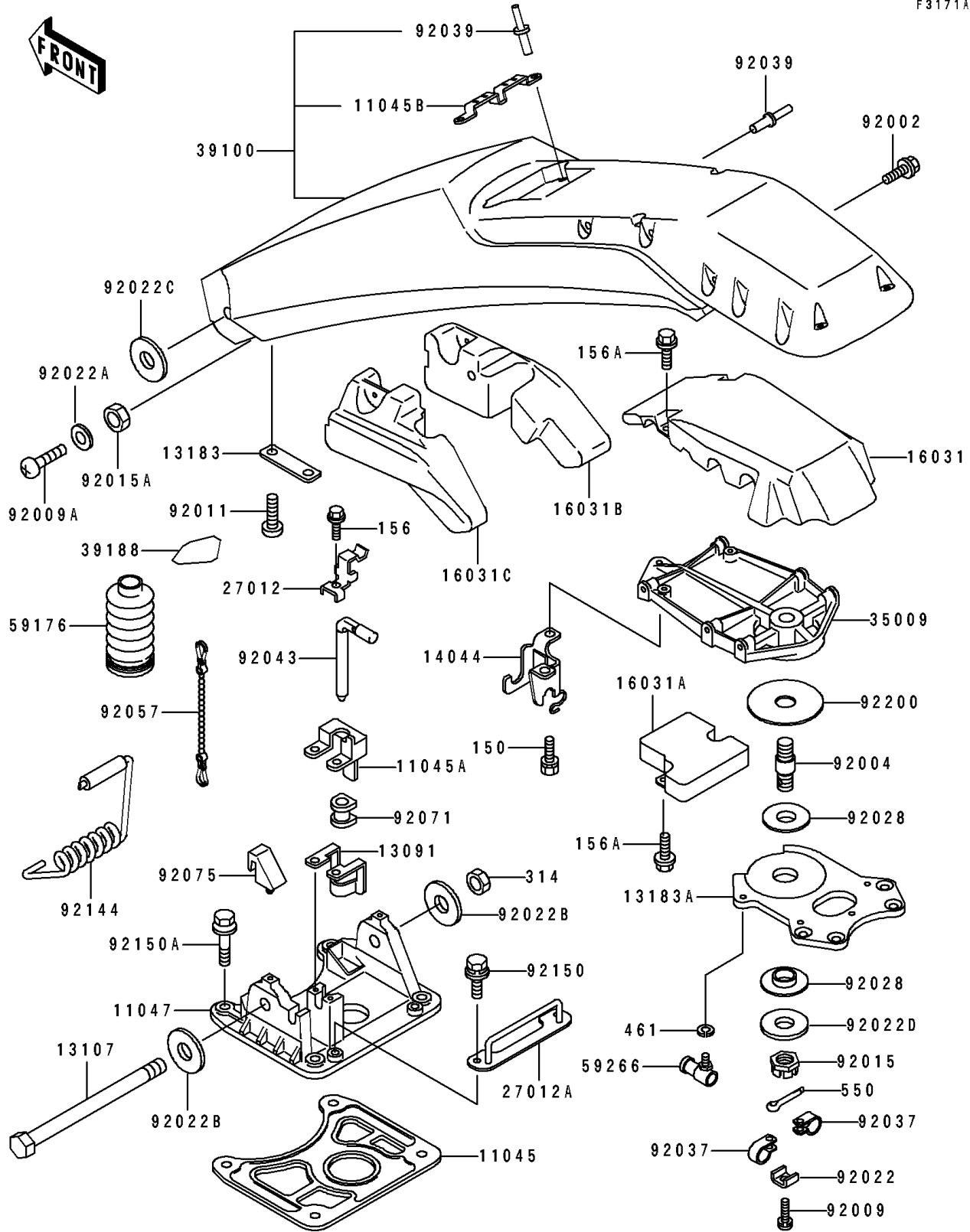

1992 650 SX PARTS LIST

Handle Pole(KAW64651 91&NAMI.)

ITEM NAME	PART NUMBER	QUANTITY
BRACKET,BACK-UP PLATE (Ref # 11045)	11045-3722	1
BRACKET,POLE STOPPER (Ref # 11045A)	11045-3728	1
BRACKET,HANDLE POLE PAD (Ref # 11045B)	11045-3733	1
BRACKET,PIVOT SHAFT (Ref # 11047)	11047-3756	1
HOLDER (Ref # 13091)	13091-3717	1
SHAFT,PIVOT (Ref # 13107)	13107-3709	1
PLATE (Ref # 13183)	13183-3720	1
PLATE,HANDLE BAR (Ref # 13183A)	13183-3786	1
HOLDER-CABLE (Ref # 14044)	14044-3001	1
FLOAT (Ref # 16031)	16031-3715	1
FLOAT,CNT (Ref # 16031A)	16031-3737	1
FLOAT,RH (Ref # 16031B)	16031-3752	1
FLOAT,LH (Ref # 16031C)	16031-3786	1
HOOK (Ref # 27012)	27012-3717	1
HOOK,ENGINE HOOD (Ref # 27012A)	27012-3733	1
BRACE (Ref # 35009)	35009-3708	1
POLE-COMP-HANDLE,M.M.BLUE (Ref # 39100)	39100-3707-TA	1
TAPE,(BLUE) (Ref # 39188)	39188-3703	AR
CAP. (Ref # 59176)	59176-514	1
JOINT-BALL (Ref # 59266)	59266-3701	1
BOLT,6X16 (Ref # 92002)	92002-3728	6
STUD (Ref # 92004)	92004-3728	1
SCREW,5X16 (Ref # 92009)	92009-3736	1
SCREW (Ref # 92009A)	92009-3738	2
SCREW (Ref # 92011)	92011-562	2
NUT,CASTLE,18MM (Ref # 92015)	92015-3006	1
NUT (Ref # 92015A)	92015-3015	2
WASHER,CLAMP (Ref # 92022)	92022-3014	1
WASHER (Ref # 92022A)	92022-3042	2

1992 650 SX PARTS LIST

Handle Pole(KAW64651 91&NAMI.)

ITEM NAME	PART NUMBER	QUANTITY
WASHER,15X34X2.0 (Ref # 92022B)	92022-3738	2
WASHER,15X36X4.5 (Ref # 92022C)	92022-3741	2
WASHER (Ref # 92022D)	92022-571	1
BUSHING (Ref # 92028)	92028-3743	2
CLAMP,LEAD WIRE (Ref # 92037)	92037-3007	2
RIVET (Ref # 92039)	92039-3701	4
PIN,POLE STOPPER (Ref # 92043)	92043-3714	1
CHAIN,COVER,L=100 (Ref # 92057)	92057-3704	1
GROMMET (Ref # 92071)	92071-3752	1
DAMPER,POLE STOPPER (Ref # 92075)	92075-3742	2
SPRING,HANDLE POLE (Ref # 92144)	92144-3716	1
BOLT,6X12 (Ref # 92150)	92150-3709	2
BOLT,8X30 (Ref # 92150A)	92150-3721	4
WASHER,20.5X80X1 (Ref # 92200)	92200-3709	1
BOLT-WS,6X12 (Ref # 150)	150R0612	2
BOLT-WP,5X10 (Ref # 156)	156R0510	2
BOLT-WP,5X12 (Ref # 156A)	156R0512	4
NUT-HEX-FINE,14MM (Ref # 314)	314R1400	1
WASHER-SPRING,6MM (Ref # 461)	461S0600	1
PIN-COTTER,4X40 (Ref # 550)	550S4040	1