

1979 KX250-A5 PARTS DIAGRAM

CRANKCASE (78-79)

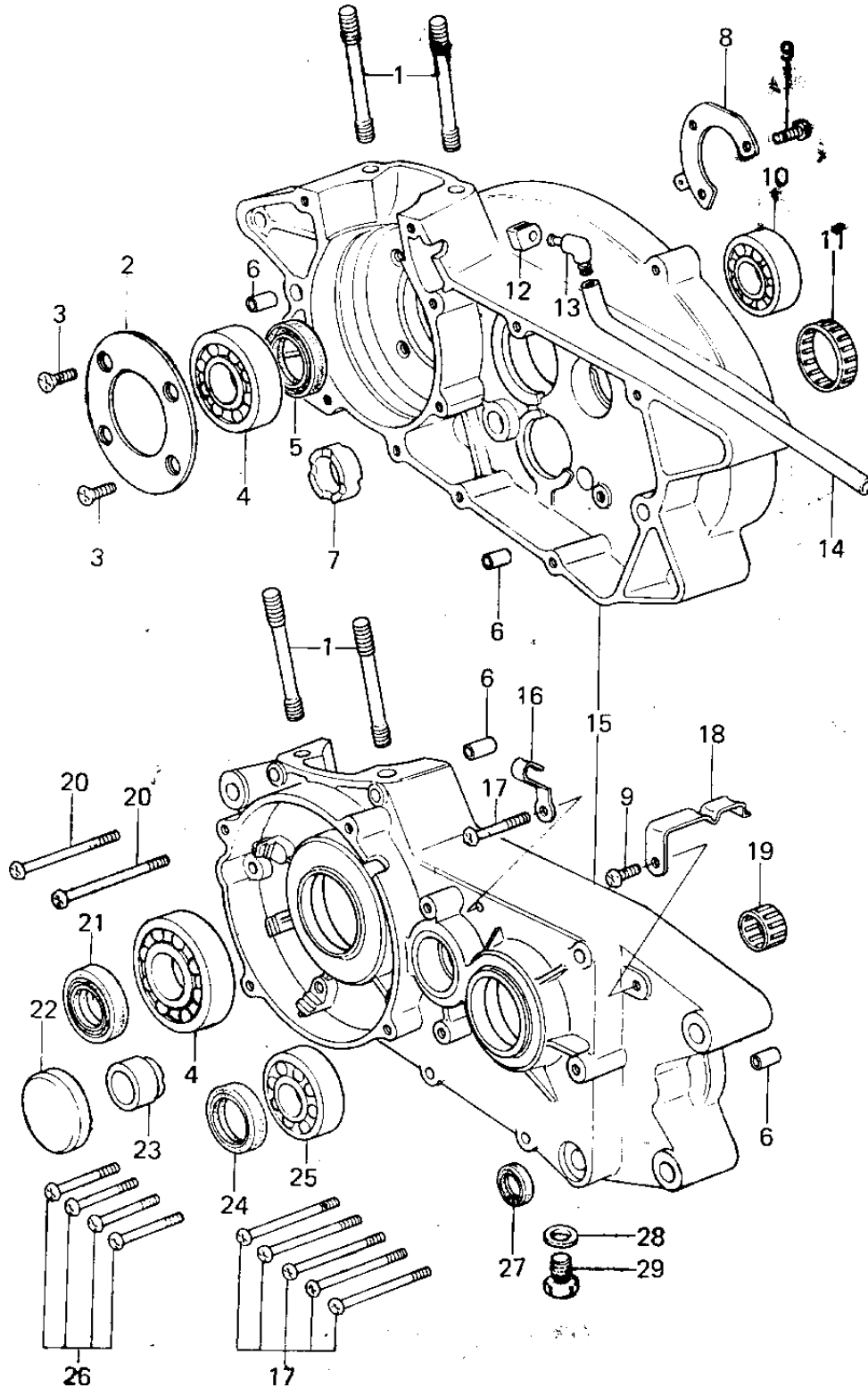

1979 KX250-A5 PARTS LIST

CRANKCASE (78-79)

ITEM NAME	PART NUMBER	QUANTITY
STUD,10X65 (Ref # 1)	92004-1006	
HOLDER,CRANK BEARING (Ref # 2)	14014-030	
SCREW CNTSNK HD 6X14 (Ref # 3)	221B0614	
BEARING,BALL,#6305SH2 (Ref # 4)	92045-1024	
BEARING,BALL,#6305SH2 (Ref # 4)	92045-1024	
OIL SEAL TB32457 (Ref # 5)	653B324507	
PIN,DOWEL,10X8.2X14 (Ref # 6)	92043-1037	
BUSHING (Ref # 7)	92028-147	
HOLDER,CRANK BEARING (Ref # 8)	14014-031	
SCREW PAN HEAD 6X14 (Ref # 9)	220B0614	
BEARING BALL #6204 (Ref # 10)	601B6204	
BEARING,NEEDLE,344012 (Ref # 11)	92046-040	
GROMMET (Ref # 12)	92071-042	
BREATHER ASSY (Ref # 13)	14069-1001	
TUBE,6X9X750 (Ref # 14)	92059-1372	
CRANK CASE SET (Ref # 15)	14001-5009	
CRANKCASE SET (Ref # 15)	14001-5024	
CLAMP CABLE (Ref # 16)	92037-016	
SCREW PAN HEAD 6X65 (Ref # 17)	220B0665	
CLAMP,WIRING HARNESS (Ref # 18)	92037-142	
BRG,N,7E-HK1412 (Ref # 19)	92046-037	
SCREW PAN HEAD 6X70 (Ref # 20)	220B0670	
OIL SEAL,TB25457 (Ref # 21)	653B254507	
CAP,CRANKCASE HOLE (Ref # 22)	92073-025	
BUSHING (Ref # 23)	92028-146	
OIL SEAL TB3040 (Ref # 24)	92050-033	
BEARING BALL #6205 (Ref # 25)	601B6205	
SCREW PAN HEAD 6X45 (Ref # 26)	220B0645	
OIL SEAL,TB13225.5 (Ref # 27)	92051-005	

1979 KX250-A5 PARTS LIST

CRANKCASE (78-79)

ITEM NAME	PART NUMBER	QUANTITY
GASKET CHECK VALVE (Ref # 28)	92065-058	
PLUG OIL DRAIN (Ref # 29)	92067-001	