

1971 A7SS-B PARTS DIAGRAM

CRANKSHAFT/PISTONS A7/A7SS

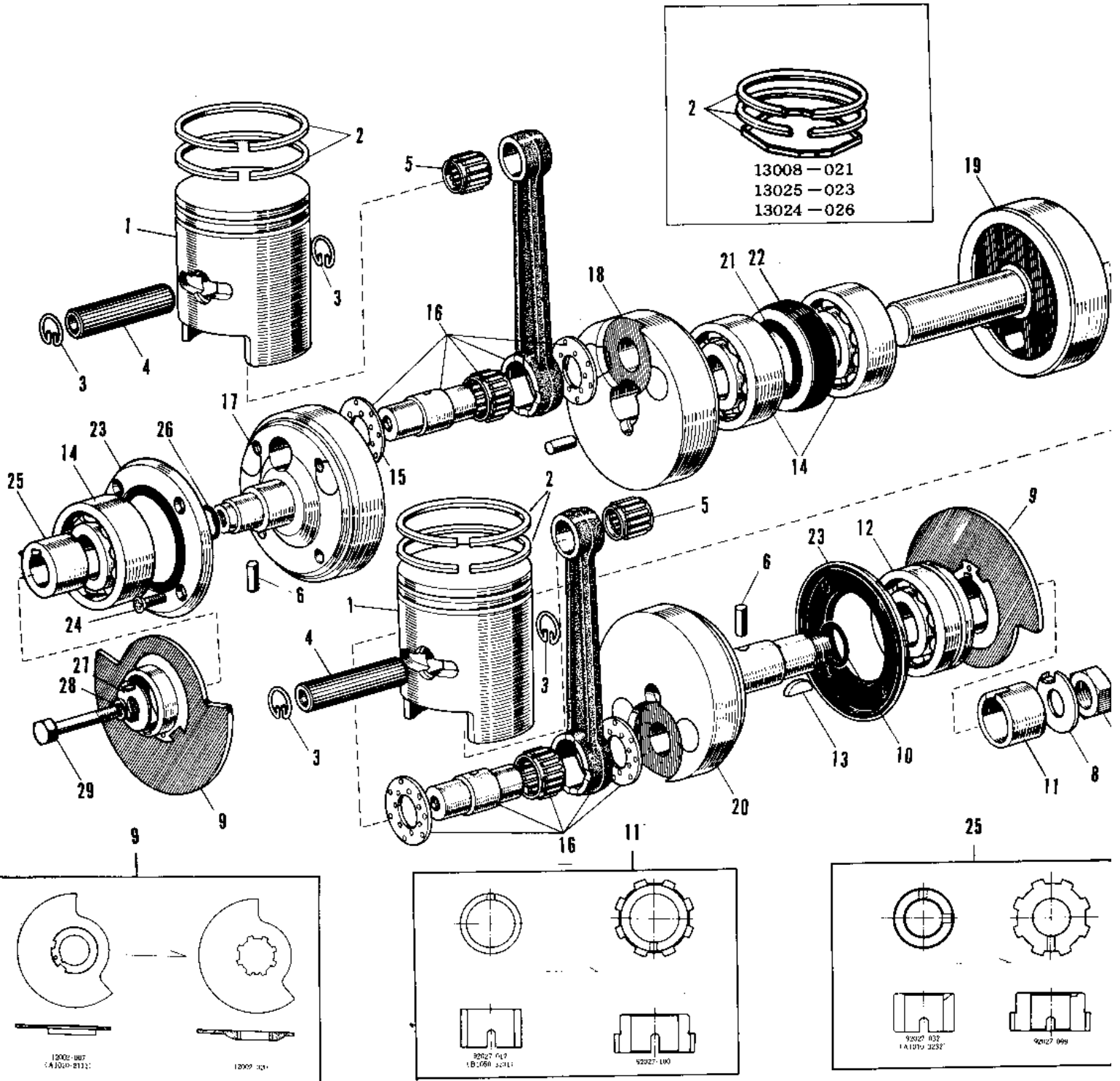

1971 A7SS-B PARTS LIST

CRANKSHAFT/PISTONS A7/A7SS

ITEM NAME	PART NUMBER	QUANTITY
PISTON STD (Ref # 1)	13001-027	2
RING SET STD (Ref # 2)	13008-021	2
CIRCLIP PISTON PIN (Ref # 3)	92036-004	4
PIN-PISTON (Ref # 4)	13002-010	2
BEARING-NEEDLE (Ref # 5)	92046-1038	2
PIN DOWEL 4X12 (Ref # 6)	610A0412	2
NUT 18MM (Ref # 7)	92015-019	1
WASHER,LOCK,18MM (Ref # 8)	92024-067	1
VALVE ROTARY DISC (Ref # 9)	12002-007	2
VALVE-ROTARY DISC (Ref # 9)	12002-020	2
"0" RING,22MM (Ref # 10)	92055-018	1
COLLAR CRANKSHAFT (Ref # 11)	92027-017	1
COLLAR-R.H CRNK SHT (Ref # 11)	92027-100	1
BALL BEARING 6305N (Ref # 12)	92045-020	1
WOODRUFF KEY (Ref # 13)	510A5100	1
CRANK - CONROD ASSY (Ref # 12, 14)	13036-021	1
BEARING BALL #6305 (Ref # 14)	601B6305	3
WASHER SIDE (Ref # 15)	92026-024	4
CONNECTING ROD SET (Ref # 16)	13044-007	2
CRANKSHAFT L.H (Ref # 17)	13037-031	1
CRANK WEB CENTER (Ref # 18)	13040-001	1
CRANKSHAFT CENTER (Ref # 19)	13039-001	1
CRANKSHAFT R.H (Ref # 20)	13038-027	1
COLLAR CRANK OIL SEAL (Ref # 21)	92027-031	1
OIL SEAL CRANKSHAFT (Ref # 22)	92056-001	1
OIL RECIEVER CRANKSHT (Ref # 23)	13045-002	2
SCREW CNTRSNK HD 5X10 (Ref # 24)	92012-001	8
SCREW OVL CNTSNK 5X10 (Ref # 24)	92012-002	8
COLLER L.H CRANK SHT (Ref # 25)	92027-032	1

1971 A7SS-B PARTS LIST

CRANKSHAFT/PISTONS A7/A7SS

ITEM NAME	PART NUMBER	QUANTITY
COLLAR-L.H CRNK SHT (Ref # 25)	92027-099	1
"0" RING,16MM (Ref # 26)	670B2016	1
WASHER LOCK 8MM (Ref # 27)	92024-007	1
WASHER SPRING 8MM (Ref # 28)	461F0800	1
BOLT HEX HEAD 8X35 (Ref # 29)	92001-030	1