

1969 Avenger SS PARTS DIAGRAM

GEAR CHANGE MECHANISM

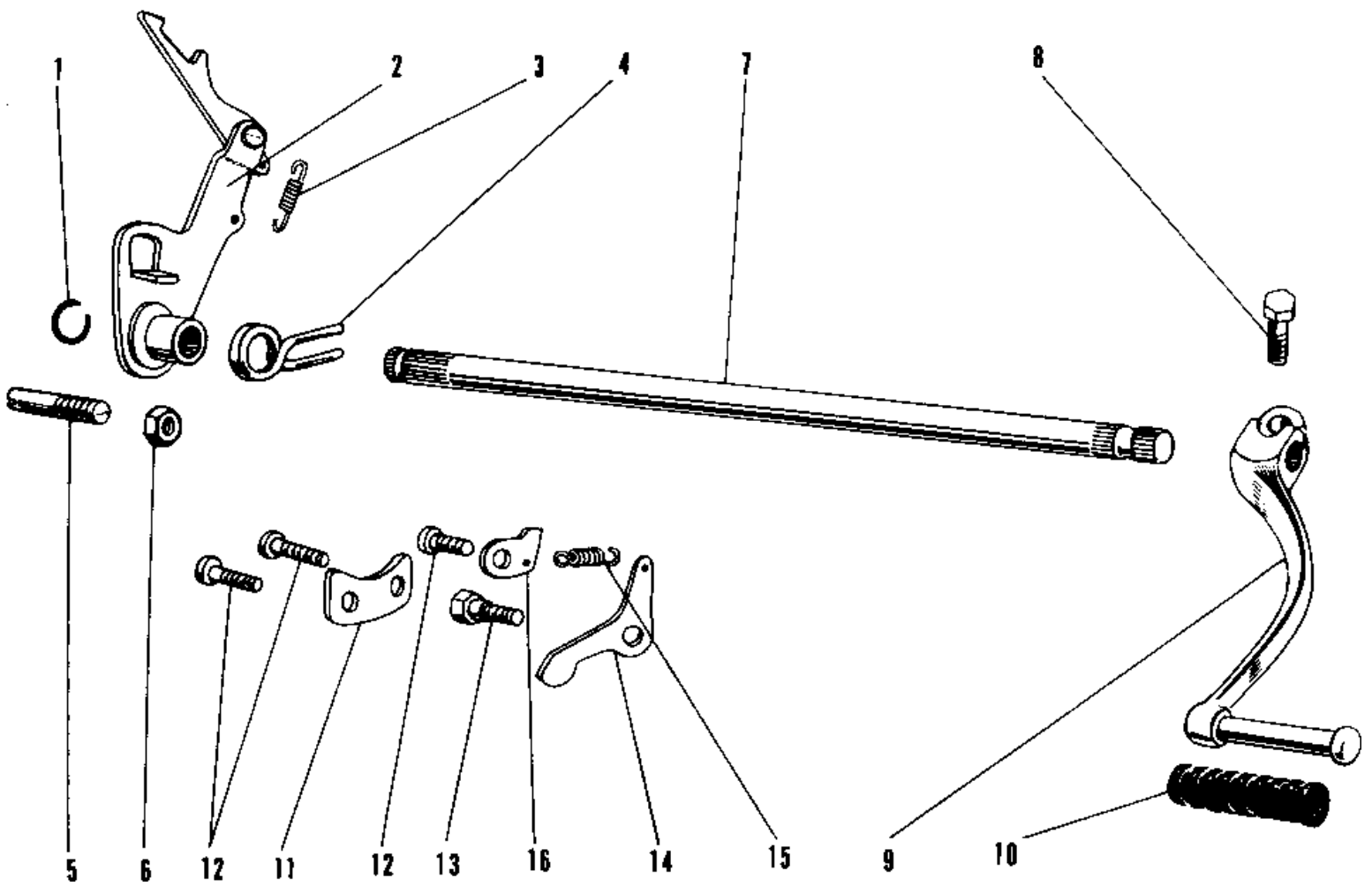

1969 Avenger SS PARTS LIST

GEAR CHANGE MECHANISM

ITEM NAME	PART NUMBER	QUANTITY
CIRCLIP 10MM (Ref # 1)	92033-002	1
LEVER ASSY GEAR CHNG (Ref # 2)	13161-007	1
SPRING,CHANGE LEVER (Ref # 3)	92144-1720	1
SPRING,TENTION (Ref # 4)	92081-1129	1
BOLT,RETURN SPRING (Ref # 5)	92001-1401	1
NUT 8MM (Ref # 6)	312B0800	1
SHAFT GEAR CHNG PEDAL (Ref # 7)	13167-008	1
BOLT-UPSET,6X20 (Ref # 8)	112G0620	1
PEDAL GEAR CHANGE (Ref # 9)	13156-019	1
RUBBER CHANGE PEDAL (Ref # 10)	13157-004	1
PLATE CHNG DRUM PSTN (Ref # 11)	13169-002	1
SCREW PAN HEAD 6X14 (Ref # 12)	220B0614	3
BOLT,CHANGE DRUM LEVE (Ref # 13)	92150-1450	1
LEVER GEAR CHNG DRUM (Ref # 14)	13168-004	1
SPRING,CHNG DRUM LEVR (Ref # 15)	92081-1045	1
PLATE CHANGE DRUM LEV (Ref # 16)	13170-004	1