

1971 A7SS-B PARTS DIAGRAM

FRAME A1/A7

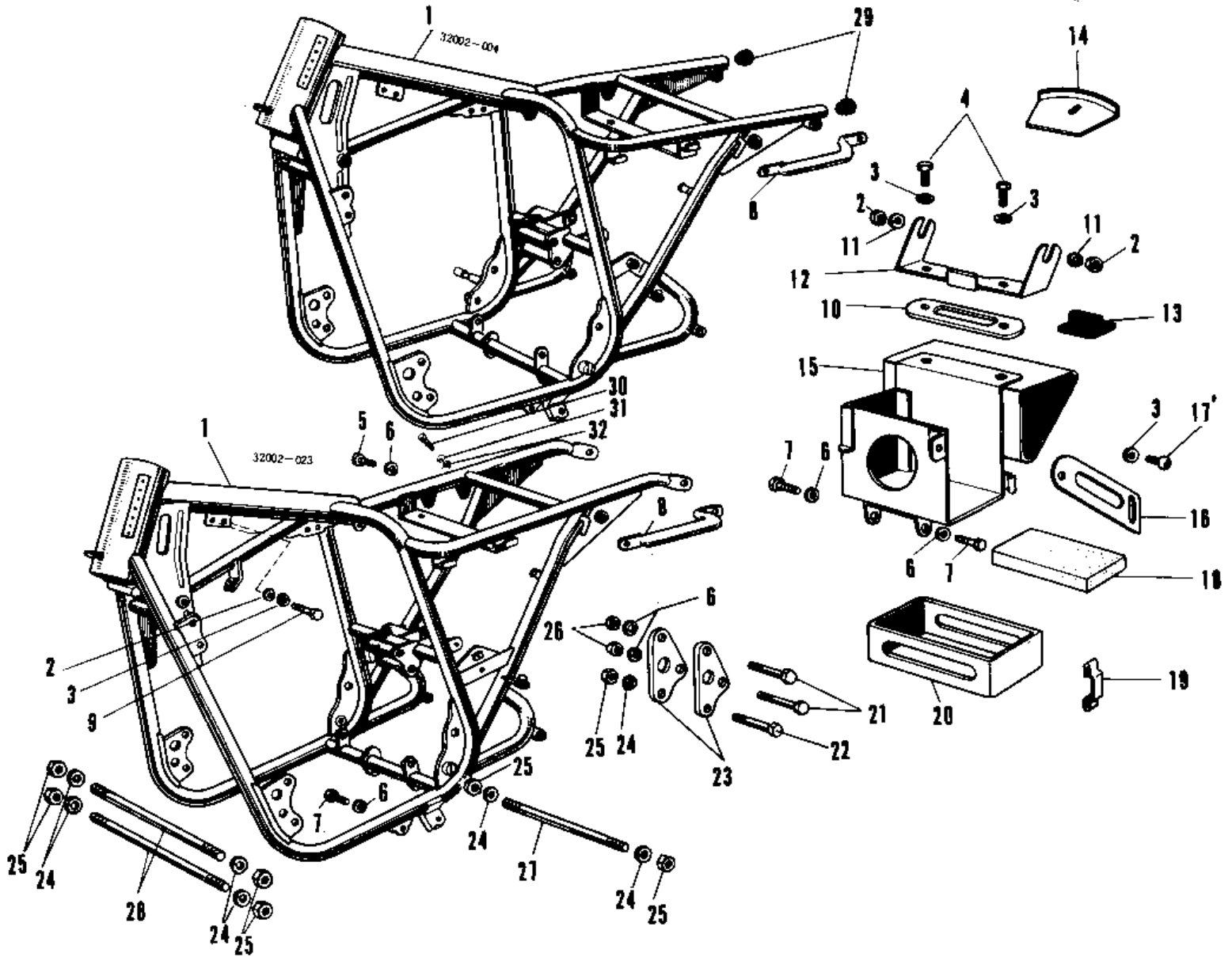

1971 A7SS-B PARTS LIST

FRAME A1/A7

ITEM NAME	PART NUMBER	QUANTITY
FRAME (Ref # 1)	32002-023	NA
NUT 6MM (Ref # 2)	311B0600	6
WASHER SPRING 6MM (Ref # 3)	461F0600	7
BOLT-UPSET,6X16 (Ref # 4)	112G0616	2
BOLT-SMALL-UPSET,8X16 (Ref # 5)	115G0816	1
WASHER SPRING 8MM (Ref # 6)	461F0800	7
BOLT-SMALL-UPSET,8X16 (Ref # 7)	115G0816	4
GRIP FRAM (Ref # 8)	32109-010	1
BOLT-UPSET,6X35 (Ref # 9)	112G0635	4
NUT TOOL BOX SET (Ref # 10)	32100-009	1
WASHER PLAIN 6MM (Ref # 11)	411B0600	2
BRACKET RECTIFIER (Ref # 12)	32095-001	2
SEAT RECTIFIER RUBBER (Ref # 13)	32103-003	1
COVER AIR CLEANER (Ref # 14)	32104-002	1
BOX BATTERY - TOOL (Ref # 15)	32099-001	1
BAND BATTERY (Ref # 16)	32100-005	1
SCREW PAN HEAD 6X16 (Ref # 17)	220B0616	1
MAT BATTERY (Ref # 18)	32103-006	1
RUBBER BATTERY SUPPRT (Ref # 20)	32103-009	1
BOLT FLANGED,8X70 (Ref # 21)	92001-1583	2
BOLT,FLANGED,10X70 (Ref # 22)	92001-1618	(1
BOLT,FLANGED,10X70 (Ref # 22)	92001-1618	1
PLATE ENG REAR HOLDER (Ref # 23)	32030-006	2
WASHER SPRING 10MM (Ref # 24)	461F1000	7
NUT,10MM (Ref # 25)	314B1000	7
NUT,8MM (Ref # 26)	311B0800	2
BOLT ENG LOWER MOUNT (Ref # 27)	92091-003	1
BOLT,10X225 (Ref # 28)	92003-181	2
SCREW PAN HEAD 6X10 (Ref # 30)	220B0610	1