

# 1966 Samurai PARTS DIAGRAM

FRONT FORK A1-A7SS 2

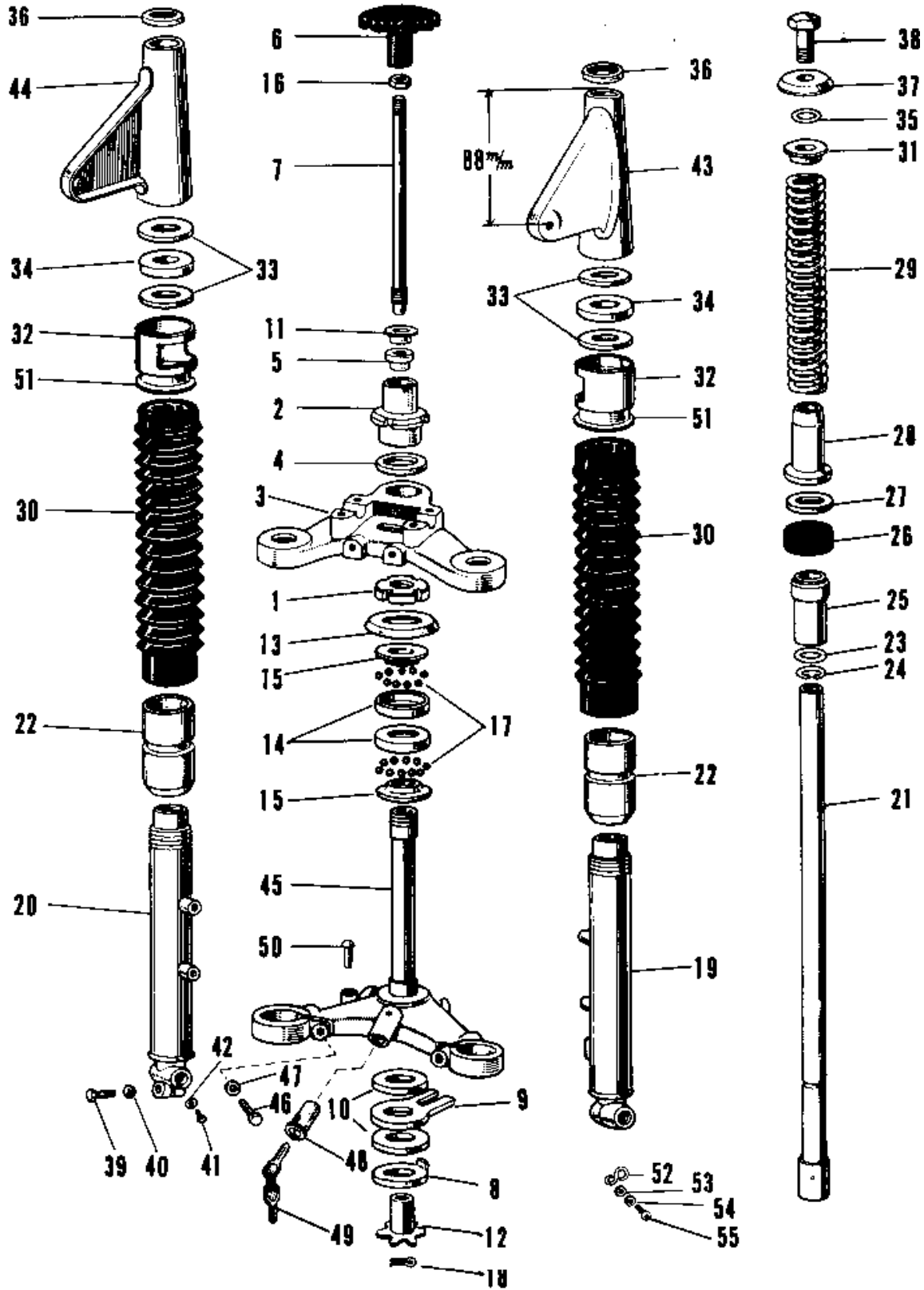

# 1966 Samurai PARTS LIST

## FRONT FORK A1-A7SS 2

ITEM NAME	PART NUMBER	QUANTITY
NUT STEERING STEM LCK (Ref # 1)	92090-007	1
NUT STEERING STEM (Ref # 2)	92090-008	1
HEAD STEERING STEM (Ref # 3)	44039-021	1
WASHER STEERING STEM (Ref # 4)	46100-001	1
BUSH STRNG DAMPER ROD (Ref # 5)	46103-001	1
KNOB STEERING DAMPER (Ref # 6)	46101-001	1
ROD STEERING DAMPER (Ref # 7)	46102-001	1
DISC STTERING DAMPER (Ref # 8)	46106-001	1
STOPPER STEERING DAMP (Ref # 9)	46105-001	1
DISC STRNG DAMP FRCTN (Ref # 10)	46104-001	2
WASHER STRNG DAMP NUT (Ref # 11)	46108-001	1
SPRING FRICTION DISC (Ref # 12)	46123-001	1
CAP STEERING STEM (Ref # 13)	46098-006	1
RACE STRNG STEM BERNG (Ref # 14)	92048-006	2
CONE STRNG STEM BERNG (Ref # 15)	92047-006	2
NUT STEERING DAMP LCK (Ref # 16)	92016-001	1
BALL STEEL 1/4' (Ref # 17)	600A0800	38
PIN COTTER 2.0X15 (Ref # 18)	550D2015	1
FRONT FORK ASSY,BLACK (Ref # 3,19~4)	44001-012-10	NA
TUBE,LH,FORK OUTER (Ref # 19)	44005-013	1
TUBE,RH,FORK OUTER (Ref # 20)	44006-011	1
TUBE FORK INNER (Ref # 21)	44013-015	1
NUT FORK OUTER TUBE (Ref # 22)	44007-010	2
'O' RING OUTER TUBE (Ref # 23)	44046-016	2
CIRCLIP Z8MM (Ref # 24)	481J2800	2
GUIDE FORK INNER TUBE (Ref # 25)	44015-006	2
OIL SEAL FORK (Ref # 26)	44009-005	2
WASHER (Ref # 27)	44043-020	2
DUST SHIELD FORK (Ref # 28)	44010-008	2

# 1966 Samurai PARTS LIST

## FRONT FORK A1-A7SS 2

ITEM NAME	PART NUMBER	QUANTITY
SPRING FORK (Ref # 29)	44026-013	2
COVER FORK DUST (Ref # 30)	44027-006	2
GUIDE FORK SPRING (Ref # 31)	44028-009	2
GUIDE FORK COVER (Ref # 32)	44030-005	2
WASHER FORK COVER (Ref # 33)	44043-021	4
GASKET FORK COVER (Ref # 34)	44045-019	2
'O' RING FORK BOLT (Ref # 35)	44046-006	2
CAP FORK COVER (Ref # 36)	44032-001	2
WASHER FORK BOLT (Ref # 37)	44043-029	2
BOLT FORK FITTING (Ref # 38)	44041-011	2
BOLT-SMALL-UPSET,8X30 (Ref # 39)	115G0830	1
WASHER SPRING 8MM (Ref # 40)	461F0800	1
SCREW PAN HEAD 4X8 (Ref # 41)	220B0408	2
SCREW PAN HEAD 4X8 (Ref # 41)	220B0408	2
GASKET FORK DRAIN PLG (Ref # 42)	44045-002	2
COVER L.H FORK BLACK (Ref # 43)	44033-021-10	1
COVER R.H FORK BLACK (Ref # 44)	44034-020-10	1
STEM STEERING (Ref # 45)	44037-015	1
BOLT PINCH (Ref # 46)	44041-010	2
WASHER SPRING 10MM (Ref # 47)	461F1000	2
UNAVAILABLE IN PRICE BOOK (Ref # 48, 49)	27017-011	1
UNAVAILABLE IN PRICE BOOK (Ref # 49)	27018-008	1
UNAVAILABLE IN PRICE BOOK (Ref # 49)	27018-008	1
UNAVAILABLE IN PRICE BOOK (Ref # 49)	27018-008	1
UNAVAILABLE IN PRICE BOOK (Ref # 49)	27018-008	1
UNAVAILABLE IN PRICE BOOK (Ref # 49)	27018-008	1
UNAVAILABLE IN PRICE BOOK (Ref # 50)	92008-006	1
HOLDER DUST COVER (Ref # 51)	44035-001	2
CLAMP CABLE (Ref # 52)	92037-026	1