

1981 KX420 PARTS DIAGRAM

CRANKCASE

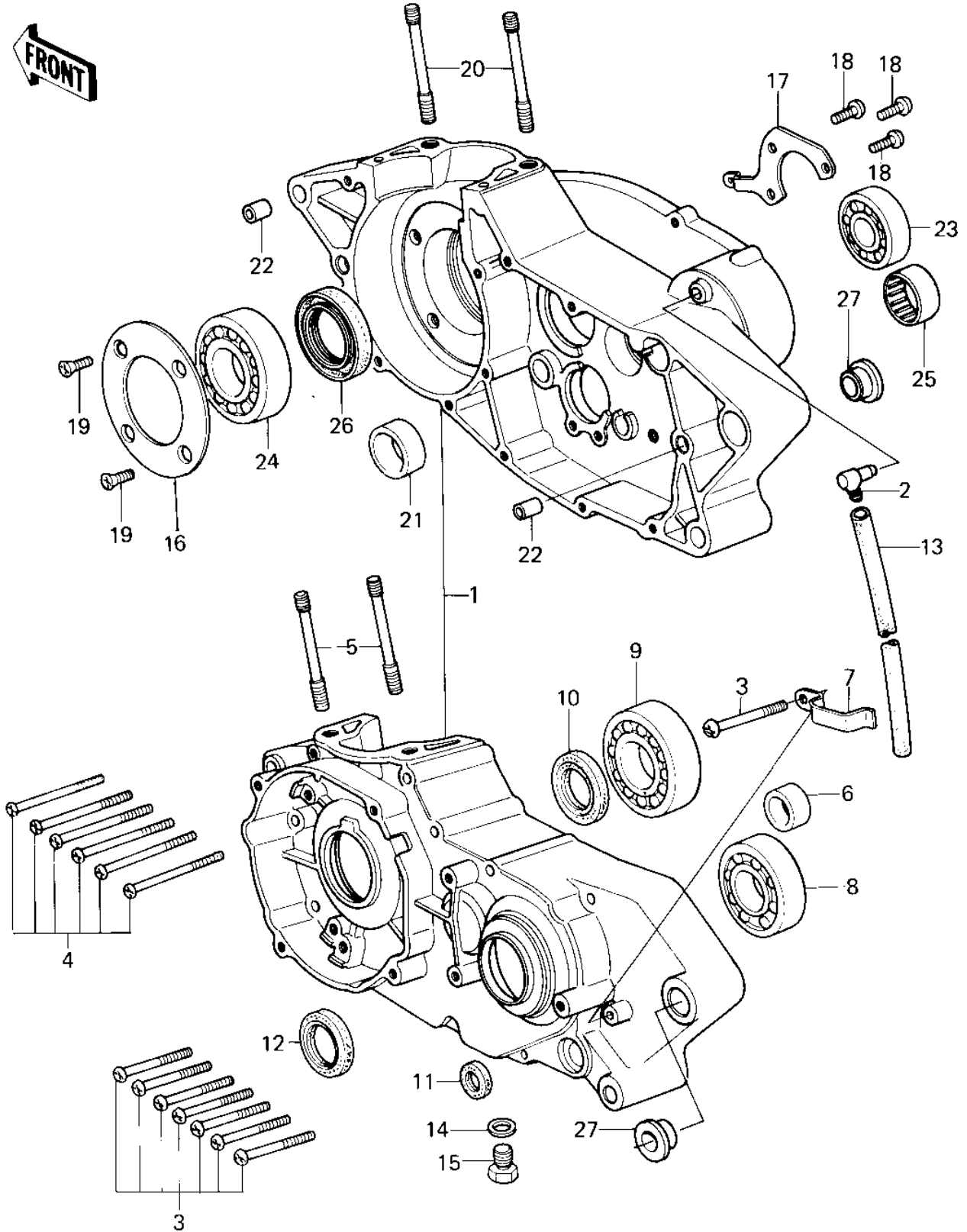

1981 KX420 PARTS LIST

CRANKCASE

ITEM NAME	PART NUMBER	QUANTITY
CRANKCASE SET,F.BLACK (Ref # 1)	14001-5044	
CRANKCASE SET (Ref # 1)	14001-5070	
BREATHER (Ref # 2)	14069-003	
SCREW PAN HEAD 6X50 (Ref # 3)	220B0650	
SCREW PAN HEAD 6X70 (Ref # 4)	220B0670	
STUD,10X72 (Ref # 5)	92004-1023	
BUSHING (Ref # 6)	92028-132	
CLAMP (Ref # 7)	92037-1073	
BEARING,BALL,#6305 (Ref # 8)	92045-1011	
BEARING,B,6306SH2-9TC (Ref # 9)	92045-1027	
OIL SEAL,TB30508 (Ref # 10)	92050-057	
OIL SEAL,CHANGE SHAFT (Ref # 11)	92050-082	
SEAL-OIL,TC32457 (Ref # 12)	92049-1159	
PIPE-BREATHER (Ref # 13)	92059-061	
GASKET CHECK VALVE (Ref # 14)	92065-058	
PLUG OIL DRAIN (Ref # 15)	92067-001	
PLATE,POSITION,CRANK (Ref # 16)	14014-1011	
PLATE,POSITION,DRIVE (Ref # 17)	14014-1012	
SCREW PAN HEAD 6X16 (Ref # 18)	220B0616	
SCREW PAN HEAD 6X14 (Ref # 18)	220B0614	
SCREW CNTSNK HD 6X16 (Ref # 19)	221B0616	
STUD,10X72 (Ref # 20)	92004-1023	
BUSHING (Ref # 21)	92028-131	
PIN,DOWEL,10X8.2X14 (Ref # 22)	92043-1037	
BEARING,BALL (Ref # 23)	92045-1006	
BEARING,B,6306SH2-9TC (Ref # 24)	92045-1027	
BEARING,NEEDLE,344012 (Ref # 25)	92046-040	
OIL SEAL,ACJ386210 (Ref # 26)	92049-1046	
BUSHING,PIVOT MOUNT (Ref # 27)	92028-1074	