

1981 KX420 PARTS DIAGRAM

BRAKE PEDAL/TORQUE LINK

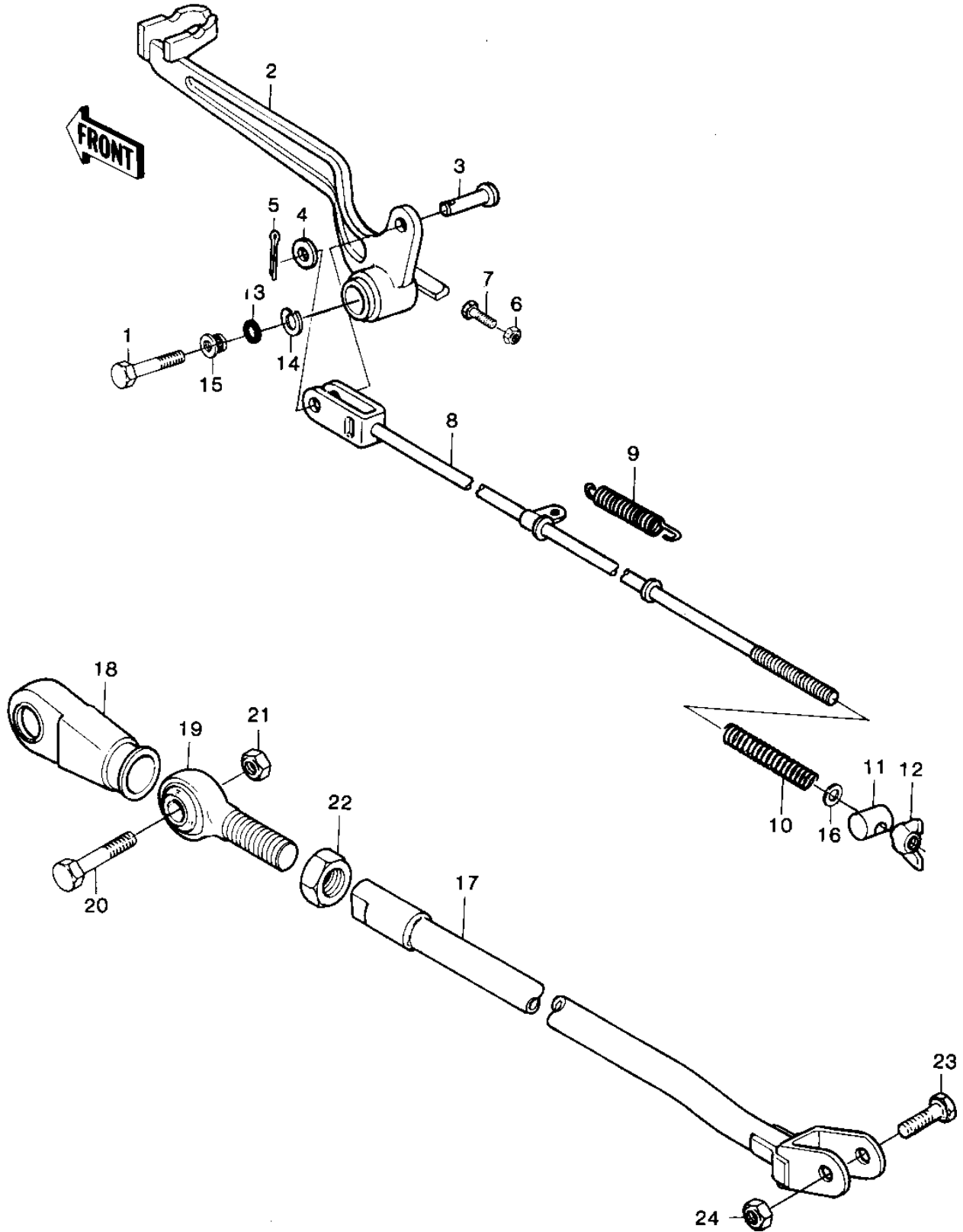

1981 KX420 PARTS LIST

BRAKE PEDAL/TORQUE LINK

ITEM NAME	PART NUMBER	QUANTITY
BOLT SMALL (Ref # 1)	114G0812	1
BOLT SMALL (Ref # 1)	114G0812	1
LEVER,BRAKE (Ref # 2)	43001-1042	1
PIN-BRAKE ROD FITTING (Ref # 3)	92043-064	1
WASHER PLAIN 6MM (Ref # 4)	410B0600	1
PIN COTTER 2.0X15 (Ref # 5)	550D2015	1
NUT 6MM (Ref # 6)	311B0600	1
BOLT 6X22 (Ref # 7)	112B0622	1
ROD,BRAKE (Ref # 8)	43011-1019	1
SPRING RETURN (Ref # 9)	92081-1059	1
SPRING,RETURN (Ref # 9)	92081-4012	1
SPRING,BRAKE ROD (Ref # 10)	43012-001	1
PIN,BRAKE (Ref # 11)	92043-1024	1
NUT,WING,6M/M (Ref # 12)	92015-4004	1
"O" RING,18MM (Ref # 13)	670B2018	1
WASHER SPRING 8MM (Ref # 14)	461F0800	1
CAP (Ref # 15)	11012-1101	1
WASHER, BRAKE ROD (Ref # 16)	92022-4003	1
TORQUE LINK,RR BRAKE (Ref # 17)	43007-1014	1
BOOT,BALL JOINT (Ref # 18)	49006-1035	1
JOINT,BALL,TORQUE RNK (Ref # 19)	59266-1003	1
BOLT,HEX HEAD,12X35 (Ref # 20)	113P1235A	1
NUT-LOCK,12MM (Ref # 21)	92019-009	1
NUT-HEX-FINE,12MM (Ref # 22)	315B1200	1
BOLT,FLANGED,8X35 (Ref # 23)	92001-1577	1
NUT,LOCK,8MM (Ref # 24)	92017-013	1
NUT,8MM (Ref # 24)	92015-1134	1